

Model U-1000

Loop Detector Operations Manual

Four Channel Menu Drive Programmable Inductive Loop Vehicle
Detector

Built-in Loop Analyzer for Each Channel

This manual contains technical information for the

Model U-1000 Loop Detector

Pn 889-2103-01 Revision: April 2020



THE FOLLOWING PRODUCT WAS DESIGNED, INSPECTED, TESTED AND
MANUFACTURED IN THE USA BY EBERLE DESIGN, INC. IN PHOENIX, ARIZONA.

INFORMATION CONTAINED HEREIN IS PROPRIETARY TECHNICAL INFORMATION OF
EBERLE DESIGN, INC. PUBLICATION, REPRODUCTION OR USE IN WHOLE OR PART IS
NOT PERMITTED EXCEPT UNDER TERMS AGREED UPON IN WRITING. ALL
REGISTERED TRADEMARKS OF EBERLE DESIGN INC. ARE UNDER
© COPYRIGHT

MAINTENANCE NOTE

**IT IS AN EBERLE DESIGN, INC. RECOMMENDATION THAT EACH UNIT BE TESTED
AT LEAST ANNUALLY TO ENSURE COMPLIANCE WITH FACTORY
SPECIFICATIONS AND MEETS PROPER OPERATIONAL STANDARDS. THE
RESULTS OF THIS TESTING WILL BE DOCUMENTED.**

Model U-1000 Operations Manual

Table of Contents

| | |
|--|-----------|
| Section 1 General Description | 1 |
| Section 2 General Characteristics | 3 |
| 2.1 Loop Frequency | 3 |
| 2.2 Sensitivity..... | 3 |
| 2.3 Presence / Pulse | 3 |
| 2.4 Call Delay..... | 3 |
| 2.5 Call Extension | 3 |
| 2.6 Max Presence Timer | 3 |
| 2.7 End-Of-Green (EOG) | 4 |
| 2.8 Option 1: Loop Inductance Display | 4 |
| 2.9 Option 2: Loop Inductance $-\Delta L/L$ Display..... | 4 |
| 2.10 Option 3: Call Extension Control..... | 4 |
| 2.11 Option 4: Noise Filter Disable | 4 |
| 2.12 Option 5: Phase Green Loop Compensation | 4 |
| 2.13 Option 9: Third Car Passage | 5 |
| 2.14 Option 10: Directional Logic..... | 5 |
| 2.15 Option 11: Audible Detect Signal..... | 6 |
| 2.16 Option 12: Detector Disconnect..... | 6 |
| Section 3 Specifications | 8 |
| 3.1 Physical..... | 8 |
| 3.2 Electrical | 8 |
| 3.3 Operational | 8 |
| 3.4 Table: Sensitivity, $-\Delta L/L$, and Response Time..... | 9 |
| 3.5 Table: Default Settings | 9 |
| 3.6 Table: Pin Assignments..... | 10 |
| Section 4 User Interface | 11 |
| Section 5 Installation and Set-Up | 12 |
| 5.1 Program Mode Display Screens | 12 |
| 5.2 Normal Mode Display Screens | 16 |
| 5.3 Loop Fail Indications | 19 |
| 5.4 Setting Sensitivity Using the Bargraph..... | 19 |
| 5.5 Setting Sensitivity for Motorcycle Detection Using the Bargraph..... | 20 |
| 5.6 Full Restore to Factory Default Settings | 20 |
| 5.7 Display Test | 20 |
| Section 6 Block Diagram | 21 |
| Section 7 Theory of Operation | 22 |
| Section 8 Maintenance and Troubleshooting | 23 |
| 8.1 Troubleshooting Power Problems..... | 23 |
| 8.2 Troubleshooting Initialization Problems | 23 |
| 8.3 Troubleshooting Loop Fail Problems | 24 |
| 8.4 Troubleshooting Intermittent Loop Fail Problems..... | 25 |
| 8.5 Troubleshooting Intermittent Detector Lock-Ups..... | 25 |
| 8.6 Troubleshooting Delay Problems..... | 26 |
| 8.7 Things to Know About Loops..... | 26 |

Section 1 General Description

This product manual was written for people installing, operating, and maintaining the Reno A & E Model U-1000 Series inductive loop vehicle detector. The Model U-1000 Series consists of two versions. The Model U-1200 is a four channel, shelf mount type inductive loop vehicle detector designed to meet or exceed NEMA Standards TS 1-1989. The Model U-1100 is a four channel, shelf mount type inductive loop vehicle detector designed specifically to conform to the specifications set forth in paragraph 86-5.01A (3b) of the 1981 version of the Caltrans Standard Specifications.

A front panel mounted, 4 pin, circular plastic connector and 10 foot wiring harness have been included with the Model U-1000 detector to support Phase Green Inputs (Delay overrides) for each channel. These inputs are used to control delay timing, phase green loop compensation, end-of-green, third car passage or detector disconnects. If these functions are required and cannot be accomplished satisfactorily through the controller, appropriate connection of the wiring harness will allow the detector to perform them.

The Model U-1000 uses a microcontroller to monitor and process signals from the loop / lead-in circuits, Phase Green Inputs, and the reset input. It uses these inputs to determine how to control the four detector channel outputs. A Liquid Crystal Display (LCD), four light emitting diodes (LEDs), and four front panel pushbuttons are used to display and program all detector functions. Several diagnostic modes are available to aid technicians and service personnel in troubleshooting detection problems.

The use of a LCD is what distinguishes this detector from that of other manufacturers. It allows more information, never before available, to be displayed to the user during normal operation of the detector. The LCD makes it easy to view and adjust all programmable detector options and settings. It is no longer necessary to check or change detector settings with DIP switches. An eight-segment bargraph at the top of the LCD can be used to provide a graphical representation of the relative change of inductance as seen by the detector at the current sensitivity level. The bargraph automatically takes into account loop size, loop inductance, number of loops, number of turns, loop geometry, lead-in length, etc. The bargraph functions as a sliding scale that relates to the programmed Sensitivity Level. The first (left-most) bargraph segment represents the minimum inductance change necessary for the detector to output a call at the currently selected sensitivity level. Larger inductance changes will indicate more segments. Each additional segment indicates that the next sensitivity level has also been met or exceeded. When used in this manner, the bargraph provides an indication of whether the sensitivity is set too high or too low, facilitating the ideal setting of the sensitivity level.

All programmed settings are stored in non-volatile memory and can only be changed by programming new settings. Loss of power or a detector reset will not change any of the programmed settings. If a loop failure occurs, the LCD will display the type of loop failure as **L lo** (for -25% change or shorted loop conditions) or **L hi** (for +25% change or open loop conditions). Each loop failure is counted and accumulated in the Loop Failure Memory. The number of failures since the last detector reset or power interruption is very useful information during analysis of intermittent loop operation.

The Model U-1000 Series detector is a scanning detector. The scanning operation sequentially activates the ON and OFF cycle of each channel's oscillator. Since only one channel's loop(s) is (are) active at a given time, crosstalk between adjacent loops connected to the same scanning detector is minimized. The Model U-1000 Series' unique scanning process also disconnects the capacitors and dampens the oscillator during the off cycle. This eliminates oscillation past the OFF point (ringing or decay) every time the loop circuit is scanned which can result in crosstalk.

When operating in the Program Mode, the Model U-1000 Series displays the real time loop frequency reading for each channel. The eight frequency settings can be incremented or decremented to provide precise frequency readings, removing any guesswork when changing frequency settings to eliminate crosstalk. NOTE: Adjacent loops connected to different channels of a non-scanning detector or different scanning detectors should be set to different frequencies with maximum separation.

The Reno A & E Model U-1000 Series utilizes the first major innovation in inductive loop detectors since the introduction of digital detectors. The programming of all of the detector's parameters with four normally open pushbutton switches not only simplifies setup by removing binary coded DIP switches, but also increases the reliability of the detector by eliminating the dependence on switch contacts during normal operation. The detailed descriptions displayed on the LCD eliminate the interpretation of numerous LED flash rates to determine the detector status. In addition, the Model U-1000 offers the versatility of software control. Special functions are possible with a simple change of the socket-mounted microprocessor. Special functions are defined as unique options (e.g. Option 5, Option 12, etc.). Special option functions are activated through the use of the LCD menu option programming.

The Model U-1000 Series is comprised of the following detectors:

U-1100-R

For retrofit applications calling for a four channel, shelf mount detector with relay outputs and an audible detect signal (buzzer) conforming to the specifications set forth in paragraph 86-5.01A (3b) of the Caltrans Standard Specifications.

- U-1100-SS For retrofit applications calling for a four channel, shelf mount detector with solid state outputs and an audible detect signal (buzzer) conforming to the specifications set forth in paragraph 86-5.01A (3b) of the Caltrans Standard Specifications.
- U-1200-R For NEMA TS 1-1989 applications calling for a four channel, shelf mount detector with relay outputs and an audible detect signal (buzzer).
- U-1200-SS For NEMA TS 1-1989 applications calling for a four channel, shelf mount detector with solid state outputs and an audible detect signal (buzzer).

Section 2 General Characteristics

2.1 LOOP FREQUENCY

There are eight (8) selectable loop frequency settings (normally in the range of 20 to 100 kilohertz) per channel. The actual loop operating frequency is a function of the loop / lead-in network and the components of the loop oscillator circuit. The digital display of the actual loop operating frequency for each setting makes it easy to quickly identify and eliminate crosstalk in the most difficult to configure intersections. The frequency display is typically very stable when the loop is vacant and vehicles are not passing nearby the loops. If the reading is varying by more than ± 1 in the last digit, this is an indication of possible crosstalk between loops.

2.2 SENSITIVITY

There are nine (9) selectable sensitivity levels per channel, plus Continuous-Call and Channel-Off. The sensitivity levels are designed so that a one level increase actually doubles the sensitivity and a one level decrease halves the sensitivity. A unique bargraph displayed on the LCD makes it easy to quickly set sensitivity at the ideal level for any loop / lead-in network configuration. (See Section 3.4 for actual detection levels at each sensitivity level.)

CONTINUOUS-CALL: When set to the Continuous-Call state, the channel output is continuously in the Call state regardless of the presence or absence of vehicles over the loop. The loop oscillator is disabled when in the Continuous-Call state. This state is indicated by **CALL** flashing on the LCD. This option is selected from the Sensitivity menu in Program Mode and is useful for checking controller response and other troubleshooting activities.

CHANNEL-OFF: When set to the Channel-Off state, the channel output is continuously in the No Call state regardless of the presence or absence of vehicles over the loop. The loop oscillator is disabled when in the Channel-Off State. This state is indicated by **OFF** flashing on the LCD. This option is selected from the Sensitivity menu in Program Mode and is useful for checking controller response and other troubleshooting activities.

2.3 PRESENCE / PULSE

One of two mutually exclusive modes of operation for each channel is available. Presence or Pulse mode is toggled by momentarily pressing either the **▲** (UP) or **▼** (DOWN) button.

PRESENCE MODE: Provides a call hold time of at least four minutes (regardless of vehicle size) and typically one to three hours for an automobile or truck.

PULSE MODE: An output Pulse of 125 ± 10 milliseconds duration is generated for each vehicle entering the loop detection zone. Each detected vehicle is instantly tuned out if it remains in the loop detection zone longer than two seconds. This enables detection of subsequent vehicles entering the loop detection zone. After each vehicle leaves the loop detection zone, the channel resumes full sensitivity within 0.5 seconds.

2.4 CALL DELAY

Each channel's Call Delay is adjustable from 0 to 255 seconds in one-second steps. Call Delay time starts counting down when a vehicle enters the loop detection zone. The remaining Call Delay time is continuously displayed on the LCD. Whenever a Phase Green Input (Call Delay Override) signal (pin 1, 2, 3, or 4 of the 4-pin connector) is active, the Call Delay function for the channel is aborted and the Call Delay time is forced to zero.

2.5 CALL EXTENSION

Each channel's Call Extension is adjustable from 0 to 25.5 seconds in 0.1-second steps. Extension time starts counting down when the last vehicle clears the loop detection zone. The remaining Call Extension time is continuously displayed on the LCD. Any vehicle entering the loop detection zone during the Call Extension time period causes the channel to return to the Detect state, and later, when the last vehicle clears the loop detection zone, the full Call Extension time starts counting down again. (See Option 3, Call Extension Control, for an alternate mode of operation for Call Extension.)

2.6 MAX PRESENCE TIMER

When activated, each channel's Max Presence timer is adjustable from 1 to 999 seconds in one-second steps. A setting of **OFF** turns the Max Presence timer off. The Max Presence function is used to limit presence time, by automatically resetting the channel. If this function is enabled (ON), the Max Presence timer begins counting down when a call is initiated and the remaining time is continuously displayed on the LCD. If the loop becomes vacant before the Max Presence timer reaches zero, the call is dropped and no automatic reset occurs. If the End-Of-Green (EOG) function is not enabled (OFF) and the call is still present when the Max Presence timer reaches zero, the channel then is automatically reset. If the EOG function is enabled (ON) and the call is still present when the Max Presence timer reaches zero, the channel enters a Wait state. The Wait state continues until either the loop becomes vacant or the Phase Green Input signal for a channel (pin 1, 2, 3, or 4 of the 4-pin connector) transitions from green to not green with the call still present. If the loop becomes vacant first, the call is dropped and no

automatic reset occurs. If the Phase Green Input transitions from green to not green while a channel is in a Wait state, the channel is automatically reset. The signals on pins 1, 2, 3, and 4 of the 4-pin connector are also called Call Delay Overrides. (See Section 3.2, Phase Green Input specification for voltage levels.)

2.7 END-OF-GREEN (EOG)

Each channel's EOG setting can be toggled ON or OFF by momentarily pressing either the ▲ (UP) or ▼ (DOWN) button. The EOG function is used to synchronize resetting of a detector with the termination of the associated phase green. The assumption is that this is the safest point in time to reset the channel. This assumption is based on the premise that at the termination of the associated phase green, traffic should be moving, and therefore, a reset would not result in the loss of a call when traffic comes to rest over the loop(s). The EOG function is only available when the Max Presence function is set between 1 and 999 seconds. It is not available when the Max Presence function is OFF. When the EOG function is enabled (ON), the channel will automatically be reset at the same time the Phase Green Input signal (pin 1, 2, 3, or 4 of the 4-pin connector) transitions from the ON state to the OFF state, if the Max Presence Time has counted down to zero and is resting in the wait state. The signals on pins 1, 2, 3, and 4 of the 4-pin connector are also called Call Delay Overrides. (See Section 3.2, Phase Green Input specifications for voltage levels.)

2.8 OPTION 1: LOOP INDUCTANCE DISPLAY

Each channel's Loop Inductance Display setting can be toggled ON or OFF by momentarily pressing either the ▲ (UP) or ▼ (DOWN) button. When this option is enabled (ON), the LCD displays the total loop inductance (actual loop inductance plus actual lead-in inductance) in microhenries for loop inductance values in the range of 20 to 2500 microhenries. By recording the inductance of the loop / lead-in circuit when it is first installed, the actual inductance can be compared to the expected inductance to help identify defective loop / lead-in circuits. Loop / lead-in inductance can be easily estimated using the simple formulas included in Section 8.7 of this manual. NOTE: Enabling this option activates it for all channels. This option is automatically disabled 15 minutes after activation or on loss of power.

2.9 OPTION 2: LOOP INDUCTANCE - Δ L/L DISPLAY

Each channel's Loop Inductance - Δ L/L Display setting can be toggled ON or OFF by momentarily pressing either the ▲ (UP) or ▼ (DOWN) button. When this option is enabled (ON), the LCD displays the percentage of inductance change (- Δ L/L value) during the Call state. To facilitate the viewing of the maximum amount of change in the - Δ L/L value while traffic is in motion over the detection zone, the channel holds the peak - Δ L/L value for a period of two seconds. NOTE: Enabling this option activates it for all channels. This option is automatically disabled 15 minutes after activation or on loss of power.

2.10 OPTION 3: CALL EXTENSION CONTROL

Each channel's Call Extension Control setting can be toggled ON or OFF by momentarily pressing either the ▲ (UP) or ▼ (DOWN) button. When this option is enabled (ON), the channel will extend calls for the programmed extension time **only** when the Phase Green Input signal (pin 1, 2, 3, or 4 of the 4-pin connector) is active. When this option is OFF, the channel extends ALL calls for the programmed extension time. The signals on pins 1, 2, 3, and 4 of the 4-pin connector are also called Call Delay Overrides. (See Section 3.2, Phase Green Input specifications for voltage levels.)

2.11 OPTION 4: NOISE FILTER DISABLE

The detector's Noise Filter Disable setting can be toggled ON or OFF by momentarily pressing either the ▲ (UP) or ▼ (DOWN) button. When Option 4 is enabled (ON), internal noise filtering is disabled thus providing a faster response time. When this option is OFF, internal noise filtering is utilized. When the detector is used in speed and/or occupancy applications, the noise filter should be disabled (i.e. Option 4 ON) to provide the most accurate data possible. It is recommended that this option not be activated. The factory default setting of OFF provides stable operation in high crosswalk environments. NOTE: Enabling this option activates it for all channels. Changing the setting of this feature will reset all detector channels.

The Loop Fail Count is not reset when the setting of Option 4 is changed. Also, changing the setting of Option 4 will not cause the prior Loop Fail indication to cease (see Section 5.3, Loop Fail Indications).

2.12 OPTION 5: PHASE GREEN LOOP COMPENSATION

Each channel's Phase Green Loop Compensation setting can be toggled ON or OFF by momentarily pressing either the ▲ (UP) or ▼ (DOWN) button. When Option 5 is enabled (ON), normal loop compensation is used until the Phase Green Input signal (pin 1, 2, 3, or 4 of the 4-pin connector) becomes active. Once the Phase Green Input signal is active, the channel desensitizes the loop. Maximum desensitization is 0.05% (- Δ L/L). This desensitization tunes out small changes, such as adjacent lane pickup, therefore minimizing the chance of max timing an empty lane. Note: A small motorcycle may also be tuned out in a short period of time following the start of Phase Green. This option is useful in minimizing false detection resulting from adjacent lane pickup when

a channel must be run with a high sensitivity setting. When Option 5 is not enabled (OFF), normal loop compensation is used.

2.13 OPTION 9: THIRD CAR PASSAGE

Each channel's Third Car Passage setting can be toggled ON or OFF by momentarily pressing either the ▲ (UP) or ▼ (DOWN) button. Option 9 is a paired channel option. This means that it takes two channels to implement the feature. Therefore, when this option is toggled ON or OFF in one channel, its paired channel is also set to the same state. In the Model U-1000, Channel 1 is paired with Channel 2 and Channel 3 is paired with Channel 4. NOTE: Option 9 is mutually exclusive with Option 10. Turning ON one option will automatically turn OFF the other option.

When Option 9 is enabled (ON), the output of the two paired channels are logically ANDed together. This means that while the loops for both of the paired channels are occupied, a call will be output on both channels. While only one channel is occupied, or neither channel is occupied, a call will not be output for either channel. The first channel with detection will enter a pending state while waiting for detection on the other paired channel. While in the pending state, the LCD will show *Pnd* on the display.

This feature is intended to be used in Protected / Permissive left turn situations. The expected installation is a stop bar loop for the left turn lane connected to one channel, a queue detection loop (with a small amount of delay time programmed) for the left turn lane connected to the other channel, and the output of either channel connected to the Vehicle Call input for the protected movement of the traffic controller.

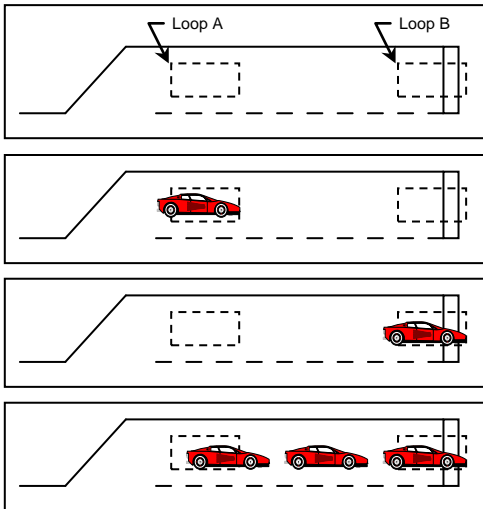

Basic Installation - Loop A is the Queue Detection loop and Loop B is the Stop Bar loop.

Car enters Loop A - No call is output.

Car proceeds to Loop B - No call is output.

Additional cars enter the left turn lane - When the back of the queue reaches Loop A while a car is still over Loop B, a call will be output.

When Third Car Passage is turned on, as the first vehicle enters the left turn lane it will drive over the queue detection loop. Since there is no vehicle over the stop bar loop, there is no call output generated. The vehicle advances to the stop bar loop. Still, no output is generated because there is no vehicle over the queue detection loop. If the vehicle traffic in the left turn lane backs up to the queue detection loop, then the stop bar loop and the queue detection loop will both be occupied at the same time. This will cause the detector to generate a call to the traffic controller to service the protected movement for the left turn. This should help clear the queue of vehicles in the left turn lane. The spacing between the stop bar loop and the queue detection loop controls the size of the queue needed to generate a call to the protected movement of the controller. The delay time on the Queue Detection loop should be sufficiently long that vehicles driving over this loop to enter the queue do not generate a call.

2.14 OPTION 10: DIRECTIONAL LOGIC

Each channel's Directional Logic setting can be toggled ON or OFF by momentarily pressing either the ▲ (UP) or ▼ (DOWN) button. Option 10 is a paired channel option. This means that it takes two channels to implement the feature. Therefore, when this option is toggled ON or OFF in one channel, its paired channel is also set to the same state. In the Model U-1000, Channel 1 is paired with Channel 2 and Channel 3 is paired with Channel 4. NOTE: Option 10 is mutually exclusive with Option 9. Turning ON one option will automatically turn OFF the other option.

When Option 10 is enabled (ON), directional logic is enabled. Directional logic starts with a detection on one channel. This channel will go into the pending state, display **Pnd** on the LCD, and NOT output a call. When both of the paired channels have detection, the last channel to have detection will output a call until the detection for the last channel ends, even if the detection ends for the first channel. None of the timing functions of the first channel with a detection will time (Delay, Extension, Max Presence, and Detector Disconnect) and the first channel will always operate in the Presence Mode regardless of the programming of the channel.

This feature is intended to be used in parking lot applications where vehicles can enter or exit from the same lane, freeway ramps for wrong way detection, and left turn lanes where other movements in the intersection tend to clip the detection zone of the left turn lane. The expected installation is two loops, one after the other in the same lane, spaced anywhere from slightly overlapping to 6 feet apart. **NOTE: Contact a Field Engineer at Reno A & E regarding proper loop configurations and spacing for specific applications.**

When Directional Detection is turned on, a vehicle entering the first loop will cause that channel to enter the pending state. As the vehicle enters the second loop while still occupying the first loop, the second channel will enter the Call state while the first channel remains in the pending state. A call is never output on the first channel with a detection. Under normal conditions both outputs can never be on at the same time. However, if one of the loops fail, both outputs will come on and stay on until the failure is corrected.

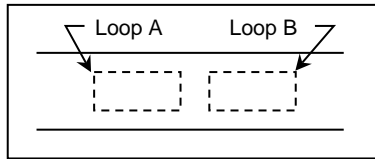

Basic Installation

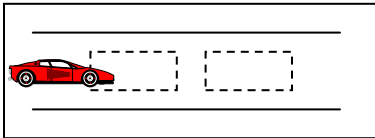

Car enters Loop A - No call is output

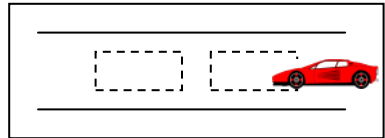

Car enters Loop B - No call is output

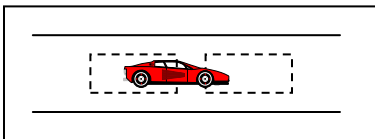

Car proceeds to Loop B
Call is output on Channel B

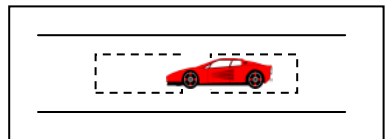

Car proceeds to Loop A
Call is output on Channel A

2.15 OPTION 11: AUDIBLE DETECT SIGNAL

Each channel's, Audible Detect Signal setting can be toggled ON or OFF by momentarily pressing either the ▲ (UP) or ▼ (DOWN) button. Only one channel can be turned ON at a time. Turning this option ON for one channel automatically turns it OFF for the other channels. When this option is enabled (ON), an audible signal will be activated whenever the detection zone for the selected channel is occupied. The audible signal indicates actual occupancy of the loop detection zone. Timing and disconnect functions have no effect on the audible signal. This feature allows a technician to watch the detection zone on the street and confirm correct detector operation without having to look at the detector display as well. **NOTE:** This option is automatically disabled 15 minutes after activation or on loss of power.

2.16 OPTION 12: DETECTOR DISCONNECT

Each channel's Detector Disconnect setting can be toggled ON or OFF and the Extension timer toggled between ON and OFF by momentarily pressing either the ▲ (UP) or ▼ (DOWN) button. The Detector Disconnect feature requires that the Phase Green Input for the channel be connected to the proper controller phase. When the Phase Green Input is not active, the channel shall operate normally. When the Phase Green Input is active, the extension

timer will start to count down at the end of each detection. If this timer reaches zero before the next detection, this channel will no longer output a call until the Phase Green Input is not active. Since the extension timer is used as a disconnect timer while in this mode, two different disconnect types are available:

Option 12.1 OFF: Extension timing still occurs and the extension timer is also the disconnect timer during phase green. This will cause the call output to remain in the Call state until disconnect occurs. This may allow the user to use gap times appropriate for the advance loops without considering the effects on the stop bar loops.

Option 12.1 ON: Extension timing is disabled and the extension timer is used as the disconnect timer. This will cause the call output to follow the occupation of the loop detection zone until disconnect occurs.

This feature is intended to be used in applications where a loop at the stop bar is not needed after any waiting queue in the associated traffic lane is moving during the green phase. The expected installation is a stop bar loop (typically a 20' to 30' long detection zone) and an advance detection loop (typically a 6' long detection zone) for a single traffic lane. This feature provides a means for keeping the stop bar loop from placing calls to the traffic controller after the stop bar loop has served its intended purpose during the beginning period of the associated green phase. The channel connected to the stop bar loop would have the Detector Disconnect feature turned ON and have a programmed extension time that functions as the disconnect time. The channel connected to the advance detection loop would be programmed as normal.

When the Detector Disconnect feature is turned ON and the signal is not green, the channel outputs calls to the traffic controller as usual. When the signal turns green, vehicles begin to move and eventually the stop bar detection zone is cleared. At the time that the stop bar detection zone is cleared the disconnect timer begins to

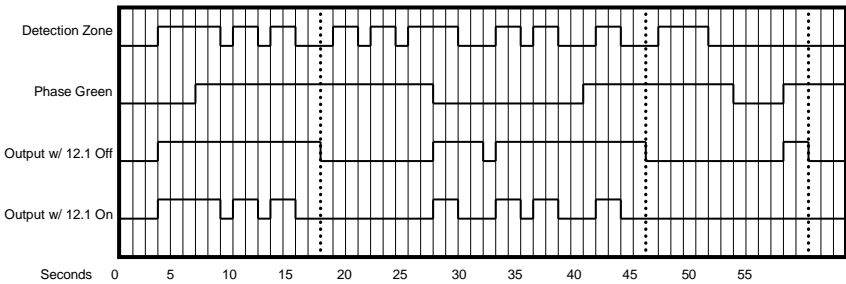

This example assumes an extension time of 2 seconds. The dotted lines show where disconnect would occur. Phase Green is the state of the light (actual Phase Green Input is inverted).

count down. If another vehicle enters the stop bar detection zone before the disconnect timer reaches zero, the channel outputs the new call to the traffic controller and the disconnect timer is reset to its initial value. Once the stop bar detection zone remains clear for a time equal to the programmed disconnect time, the detector channel is disabled and will not generate any further calls to the traffic controller until after the green has terminated. When the stop bar detection loop is disabled, the green phase can only be extended by vehicles detected by the advance detection loop. NOTE: The disconnect timer will always time an initial gap each time that the phase turns green. If Option 12.1 is OFF, the channel will generate an output for the specified extension time at the start of each green phase.

Section 3 Specifications

3.1 PHYSICAL

WEIGHT: 34 oz. (964 gm).

SIZE: 6.40 inches (16.25 cm) high x 2.48 inches (6.30 cm) wide x 6.38 inches (16.19 cm) long (excluding connectors). Connectors add .675 inch (1.71 cm) to depth measurement.

OPERATING TEMPERATURE: -40° F to +180° F (-40° C to +82° C).

CIRCUIT BOARD: Printed circuit boards are 0.062 inch thick FR4 material with 2 oz. copper on both sides and plated through holes. Circuit board and components are conformal coated with polyurethane.

CONNECTORS: MS3102A-22-14P, 19 pin male. See section 3.6 for pin assignments.
AMP 206061-1, 4 pin male. 10 foot Harness with mating connector included.

3.2 ELECTRICAL

POWER: 89 to 135 VAC, 50/60 Hz, 6 Watts maximum.

LOOP INDUCTANCE RANGE: 20 to 2500 microhenries with a Q factor of 5 or greater.

LOOP INPUTS: Transformer isolated. The minimum capacitance added is 0.068 microfarad.

LIGHTNING PROTECTION: Meets and/or exceeds all applicable NEMA TS 1-1989 specifications for transient voltage protection. Each channel can tolerate, without damage, a 10 microfarad capacitor charged to 2,000 volts being discharged directly into the loop input terminals, or a 10 microfarad capacitor charged to 2,000 volts being discharged between either loop terminal and earth ground.

RESET: Meets and/or exceeds NEMA TS 1-1989 detector specifications. The detector can be reset by removing and reapplying power or by changing the setting of Option 4 (Noise Filter Disable). Each detector channel can be independently reset by pressing the CHAN button until the desired channel is selected, then pressing and holding the CHAN button for three seconds. Also, changing either the sensitivity or loop frequency of a channel will reset that channel.

PHASE GREEN INPUTS: Also known as Call Delay Overrides. Meets and/or exceeds all NEMA TS 1-1989 requirements. Application of a high state voltage (89 to 135 VAC) to pin 1 (Ch. 1) and/or pin 2 (Ch. 2) and/or pin 3 (Ch. 3) and/or pin 4 (Ch. 4) of the 4-pin connector causes the delay timer for the channel to abort the delay timing function and also provides control for Phase Green Loop Compensation, Max Presence Timing (End-of-Green), Extension timing, and Detector Disconnect, if the features are programmed.

RELAY RATING: The relay contacts are rated for 6 Amps maximum, 150 VDC maximum, and 180 Watts maximum switched power.

SOLID STATE OUTPUT RATING: Optically isolated. 30 VDC maximum collector (drain) to emitter (source). 100 mA maximum saturation current. 2 VDC maximum transistor saturation voltage. The output is protected with a 33-volt Zener diode connected between the collector (drain) and emitter (source).

3.3 OPERATIONAL

DISPLAY: The LCD backlighting illuminates whenever any pushbutton is pressed. The backlighting will extinguish 15 minutes after the last pushbutton press.

DETECT INDICATOR: Each channel has a super bright, high intensity, red light emitting diode (LED) to indicate a Call Output, Delay Timing, Extension Timing, Pending State, or Failed Loop condition.

RESPONSE TIME: Meets or exceeds NEMA TS 1-1989 response time specifications. (See Section 3.4 for actual response times.)

SELF-TUNING: The detector automatically tunes and is operational within two seconds after application of power or after being reset. Full sensitivity and hold time require 30 seconds of operation.

ENVIRONMENTAL & TRACKING: The detector is fully self-compensating for environmental changes and loop drift over the full temperature range and the entire loop inductance range.

GROUNDING LOOP OPERATION: The loop isolation transformer allows operation with poor quality loops (which may include one short to ground at a single point).

LOOP FEEDER LENGTH: Up to 5000 feet (1500 m) maximum with proper feeder cable and appropriate loops.

LOOP (FAIL) MONITOR: If the total inductance of the channel's loop input network goes out of the range specified for the detector, or rapidly changes by more than $\pm 25\%$, the channel will immediately enter the Fail-Safe mode and

display **LOOP FAIL** on the LCD. The type of loop failure will also be displayed as **L lo** (for -25% change or shorted loop conditions) or **L hi** (for +25% change or open loop conditions). This will continue as long as the loop fault exists. **However, if the detector is reset, or power is momentarily lost, the detector will return if the loop inductance is within the acceptable range. If any type of loop failure occurs in one (or more) loop(s) in a group of two or more loops wired in parallel, the detector will not respond with a Fail-Safe output following any type of reset. It is essential that multiple loops wired to a common detector channel always be wired in series to ensure Fail-Safe operation under all circumstances.** At the time of a loop failure, the channel's LED will begin to flash at a rate of three flashes per second. The LED will continue this display pattern until the channel is manually reset or power is removed. If the loop self-heals, the **LOOP FAIL** message on the LCD will extinguish and the channel will resume operation in a normal manner; except the LED will continue the three flashes per second display pattern, thus providing an alert that a prior Loop Fail condition has occurred. Each loop failure for the channel is counted and accumulated into the Loop Fail Memory. The total number of loop failures written into the Loop Fail Memory (since the last power interruption or manual reset) is viewed by stepping through the channel's functions in Program Mode until the LOOP FAIL message is displayed.

3.4 TABLE: SENSITIVITY, -ΔL/L, AND RESPONSE TIME

| Sensitivity | -ΔL/L | Response Time Noise Filter Enabled (Option 4 OFF) | Response Time Noise Filter Disabled (Option 4 ON) |
|-------------|---------|---|---|
| OFF | ----- | ----- | ----- |
| 1 | 0.64% | 160 ±50 ms | 35 ±7 ms |
| 2 | 0.32% | 160 ±50 ms | 35 ±7 ms |
| 3 | 0.16% | 160 ±50 ms | 35 ±7 ms |
| 4 | 0.08% | 160 ±50 ms | 35 ±7 ms |
| 5 | 0.04% | 160 ±50 ms | 35 ±7 ms |
| 6 | 0.02% | 160 ±50 ms | 48 ±10 ms |
| 7 | 0.01% | 160 ±50 ms | 79 ±17 ms |
| 8 | 0.005% | 160 ±50 ms | 138 ±28 ms |
| 9 | 0.0025% | 160 ±50 ms | 261 ±51 ms |
| CALL | ----- | ----- | ----- |

NOTE: Entries in this table are based on the assumption that both channels are set to the same sensitivity. To approximate response time for a detector with the channels set to different sensitivities, look up the response time for each channel and divide it by two, then add these times together.

3.5 TABLE: DEFAULT SETTINGS

| Function | Channel 1 | Channel 2 | Channel 3 | Channel 4 |
|--|-----------|-----------|-----------|-----------|
| Frequency | 2 | 4 | 6 | 8 |
| Sensitivity | 6 | 6 | 6 | 6 |
| Delay Time | 0 | 0 | 0 | 0 |
| Extension Time | 0 | 0 | 0 | 0 |
| Max Presence Time | OFF | OFF | OFF | OFF |
| Presence / Pulse Mode | Presence | Presence | Presence | Presence |
| EOG | OFF | OFF | OFF | OFF |
| Option 1 - Loop Inductance Display | OFF | OFF | OFF | OFF |
| Option 2 - Loop Inductance -ΔL/L Display | OFF | OFF | OFF | OFF |
| Option 3 - Call Extension Control | OFF | OFF | OFF | OFF |
| Option 4 - Noise Filter Disable | OFF | OFF | OFF | OFF |
| Option 5 - Phase Green Loop Compensation | OFF | OFF | OFF | OFF |
| Option 9 - Third Car Passage | OFF | OFF | OFF | OFF |
| Option 10 - Directional Logic | OFF | OFF | OFF | OFF |
| Option 11 - Audible Detect Signal | OFF | OFF | OFF | OFF |
| Option 12.0 - Detector Disconnect | OFF | OFF | OFF | OFF |
| Option 12.1 - Detector Disconnect Type | OFF | OFF | OFF | OFF |

3.6 TABLE: PIN ASSIGNMENTS

1200 SERIES

RELAY OUTPUTS

| Pin | Function |
|-----|---------------------------------------|
| A | Power, Neutral, 120 VAC |
| B | Channel 4 Output, Relay Common |
| C | Power, Line, 120 VAC |
| D | Channel 1 Loop Input |
| E | Channel 1 Loop Input |
| F | Channel 2 Loop Input |
| G | Channel 2 Loop Input |
| H | Chassis Ground |
| J | Channel 3 Loop Input |
| K | Channel 3 Loop Input |
| L | Channel 4 Loop Input |
| M | Channel 4 Loop Input |
| N | Channel 1 Output, Relay Normally Open |
| P | Channel 1 Output, Relay Common |
| R | Channel 2 Output, Relay Common |
| S | Channel 2 Output, Relay Normally Open |
| T | Channel 3 Output, Relay Common |
| U | Channel 3 Output, Relay Normally Open |
| V | Channel 4 Output, Relay Normally Open |

SOLID STATE OUTPUTS

| Pin | Function |
|-----|-------------------------------------|
| A | Power, Neutral, 120 VAC |
| B | Channel 4 Output, Emitter (Source) |
| C | Power, Line, 120 VAC |
| D | Channel 1 Loop Input |
| E | Channel 1 Loop Input |
| F | Channel 2 Loop Input |
| G | Channel 2 Loop Input |
| H | Chassis Ground |
| J | Channel 3 Loop Input |
| K | Channel 3 Loop Input |
| L | Channel 4 Loop Input |
| M | Channel 4 Loop Input |
| N | Channel 1 Output, Collector (Drain) |
| P | Channel 1 Output, Emitter (Source) |
| R | Channel 2 Output, Emitter (Source) |
| S | Channel 2 Output, Collector (Drain) |
| T | Channel 3 Output, Emitter (Source) |
| U | Channel 3 Output, Collector (Drain) |
| V | Channel 4 Output, Collector (Drain) |

NOTE: Relay contact states are shown with power applied, loop(s) connected, and no vehicle(s) present.

1100 SERIES

RELAY OUTPUTS

| Pin | Function |
|-----|---------------------------------------|
| A | Power, Neutral, 120 VAC |
| B | Channel 4 Output, Relay Common |
| C | Power, Line, 120 VAC |
| D | Channel 1 Loop Input |
| E | Channel 1 Loop Input |
| F | Channel 2 Loop Input |
| G | Channel 2 Loop Input |
| H | Chassis Ground |
| J | Channel 3 Loop Input |
| K | Channel 3 Loop Input |
| L | Channel 4 Loop Input |
| M | Channel 4 Loop Input |
| N | Channel 1 Output, Relay Normally Open |
| P | Channel 1 Output, Relay Common |
| R | Channel 2 Output, Relay Normally Open |
| S | Channel 2 Output, Relay Common |
| T | Channel 3 Output, Relay Normally Open |
| U | Channel 3 Output, Relay Common |
| V | Channel 4 Output, Relay Normally Open |

SOLID STATE OUTPUTS

| Pin | Function |
|-----|-------------------------------------|
| A | Power, Neutral, 120 VAC |
| B | Channel 4 Output, Emitter (Source) |
| C | Power, Line, 120 VAC |
| D | Channel 1 Loop Input |
| E | Channel 1 Loop Input |
| F | Channel 2 Loop Input |
| G | Channel 2 Loop Input |
| H | Chassis Ground |
| J | Channel 3 Loop Input |
| K | Channel 3 Loop Input |
| L | Channel 4 Loop Input |
| M | Channel 4 Loop Input |
| N | Channel 1 Output, Collector (Drain) |
| P | Channel 1 Output, Emitter (Source) |
| R | Channel 2 Output, Collector (Drain) |
| S | Channel 2 Output, Emitter (Source) |
| T | Channel 3 Output, Collector (Drain) |
| U | Channel 3 Output, Emitter (Source) |
| V | Channel 4 Output, Collector (Drain) |

NOTE: Relay contact states are shown with power applied, loop(s) connected, and no vehicle(s) present.

4-PIN PHASE GREEN CONNECTOR (Mating harness P/N 415-2104-10 is included with the detector.)

| Pin | Wire Color | Function |
|-----|------------|---|
| 1 | Brown | Channel 1 Phase Green Input [Delay Override (120 VAC) Line] |
| 2 | Red | Channel 2 Phase Green Input [Delay Override (120 VAC) Line] |
| 3 | Orange | Channel 3 Phase Green Input [Delay Override (120 VAC) Line] |
| 4 | Yellow | Channel 4 Phase Green Input [Delay Override (120 VAC) Line] |

NOTE: To eliminate any possibility of electric shock, this connector should only be engaged or removed when the primary MS connector is engaged.

Section 4 User Interface

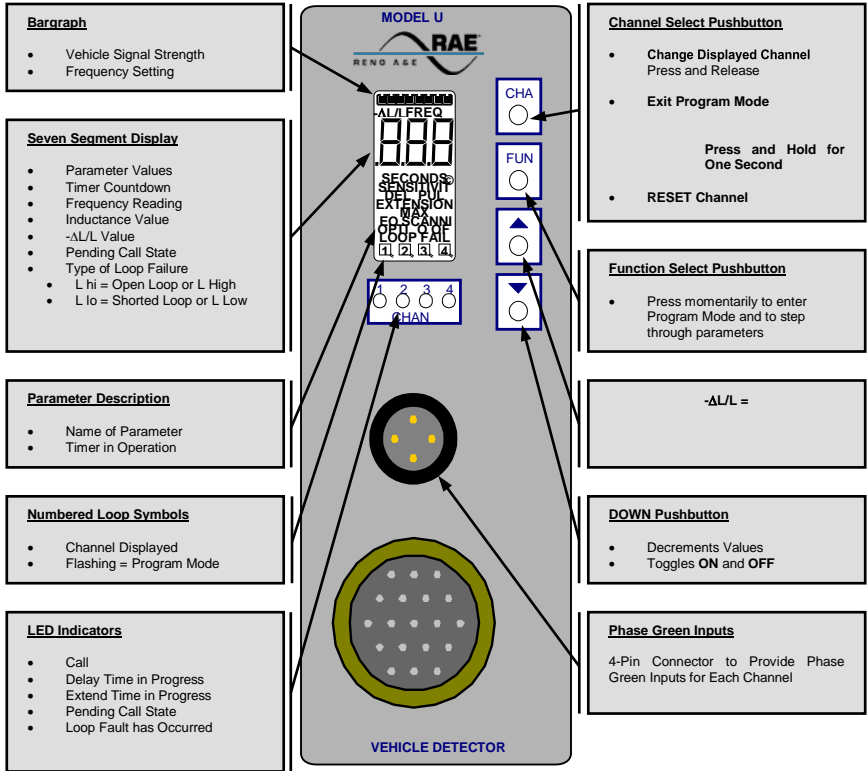

NOTE: There are no internal switches or jumpers to set.

Section 5 Installation and Set-Up

The detector has no DIP switches or jumpers to configure. Connect an appropriately wired harness to the detector and apply power. If the detector is not new from the factory, it may be advantageous to reset the detector back to the factory defaults to avoid having to check every setting for each channel. To reset the detector to factory default, press and hold all four pushbutton switches simultaneously for five seconds. When all four buttons are depressed, the display will start counting down from five (5). When the countdown reaches zero (0), releasing the pushbuttons will reload the factory defaults and reset all channels.

All operating parameters can be adjusted from the front panel. The detector continues to operate normally while it is in the Program Mode. The value currently displayed is always the actual value being used. Example: If you are changing the delay time, the time displayed at the instant that a vehicle entered the detection zone for that channel would be the value used for the delay timer.

Pressing the FUNC button enters the Program Mode. The FUNC button has an auto repeat function. This allows quick navigation to the desired parameter. The FUNC button only moves forward through all of the parameters. There is no way to move backwards through the parameters.

While viewing any parameter, pressing the CHAN button will display the same parameter for the next channel. The currently selected channel is indicated at the bottom of the LCD. Pressing and holding the CHAN button for one second will exit the Program Mode and return to the Normal Mode.

Pressing and holding either the ▲ (UP) or ▼ (DOWN) button will cause the value to change rapidly until the button is released.

5.1 PROGRAM MODE DISPLAY SCREENS



PARAMETERFrequency.
SETTINGS.....Eight (8) Selections - 1 to 8.
SETTING DISPLAYEDBargraph indicates settings from 1 (left) to 8 (right).
7 SEGMENT DISPLAYActual Frequency of the loop circuit. Typically 20.0 to 99.9 kilohertz.
DEFAULT SETTING.....Channel 1 = 2, Channel 2 = 4, Channel 3 = 6, Channel 4 = 8.
EXAMPLE.....Frequency setting 4 is selected for channel 1. The loop frequency is 34.9 kHz.
NOTES.....Changing the frequency will reset the channel. An unstable frequency display varying more than ± 0.2 kilohertz may indicate loop crosstalk or other interference.



PARAMETERSensitivity.
SETTINGS.....11 Selections - 1 to 9, OFF, or CALL.
SETTING DISPLAYED7-segment display will show the currently selected setting.
7 SEGMENT DISPLAYCurrently selected Sensitivity.
DEFAULT SETTING.....6 for all channels.
EXAMPLE.....Sensitivity 5 is selected for channel 1.
NOTES.....Changing the sensitivity will reset the channel. If the channel is in the call state when viewing this parameter, the bargraph will show the strength of vehicle calls so that the correct sensitivity can be verified from this screen.

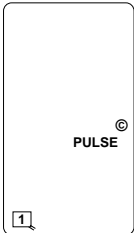

PARAMETERPresence / Pulse Mode.
SETTINGS.....Presence or Pulse.
SETTING DISPLAYEDThe word PRESENCE or PULSE will be displayed.
7 SEGMENT DISPLAYBlank.
DEFAULT SETTING.....Presence for all channels.
EXAMPLE.....Pulse Mode is selected for channel 1.
NOTES.....If the channel is in the call state when this parameter is changed, the change will not take effect until the detection zone is empty or the channel is reset.



PARAMETERDelay.
SETTINGS256 Selections - 0 to 255 Seconds in one-second steps.
SETTING DISPLAYED7-segment display will show the currently selected setting.
7 SEGMENT DISPLAYCurrently selected Delay time in seconds.
DEFAULT SETTING0 seconds for all channels.
EXAMPLEDelay of 10 seconds selected for channel 1.
NOTESIf the channel's detection zone is occupied when this parameter is changed, the change will not take effect until the detection zone is empty or the channel is reset.



PARAMETERExtension.
SETTINGS256 Selections - 0 to 25.5 Seconds in 0.1-second steps.
SETTING DISPLAYED7-segment display will show the currently selected setting.
7 SEGMENT DISPLAYCurrently selected Extension time in seconds.
DEFAULT SETTING0 seconds for all channels.
EXAMPLEExtension of 2.5 seconds selected for channel 1.
NOTESThis parameter will hold the Disconnect timer value if Option 12.0 is ON and extension will not be added to a vehicle call if Option 12.0 and 12.1 are ON.



PARAMETERMax Presence.
SETTINGS1000 Selections - 1 second to 999 seconds or OFF.
SETTING DISPLAYED7-segment display will show currently selected setting.
7 SEGMENT DISPLAYCurrently selected Max Presence time in seconds.
DEFAULT SETTINGOFF for all channels.
EXAMPLEMax Presence is turned OFF for channel 1.
NOTESIf the channel's detection zone is occupied when this parameter is changed, the change will not take effect until the detection zone is empty or the channel is reset.

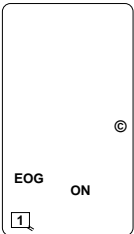

PARAMETEREOG (End Of Green).
SETTINGSON or OFF.
SETTING DISPLAYEDThe word ON or OFF will be displayed.
7 SEGMENT DISPLAYBlank.
DEFAULT SETTINGOFF for all channels.
EXAMPLEEOG is turned ON for channel 1.
NOTESThis parameter is only displayed if the Max Presence setting for the channel has been programmed with a value between 1 and 999. Operation of this feature requires that the Phase Green Inputs be correctly connected to the controller phase green circuitry.

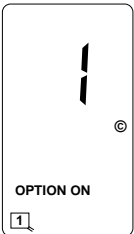

PARAMETEROption 1 (Loop / Lead-In Inductance Display).
SETTINGSON or OFF.
SETTING DISPLAYEDThe word ON or OFF will be displayed.
7 SEGMENT DISPLAYThe number of this option.
DEFAULT SETTINGOFF for all channels.
EXAMPLEOption 1 is turned ON for all channels.
NOTESThis option is a detector wide setting. Changing it for one channel changes it for all channels. This option will automatically turn off 15 minutes after being activated or on loss of power.

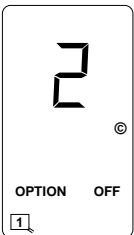

PARAMETEROption 2 (Percentage of Inductance change, -ΔL/L).
SETTINGSON or OFF.
SETTING DISPLAYEDThe word ON or OFF will be displayed.
7 SEGMENT DISPLAYThe number of this option.
DEFAULT SETTINGOFF for all channels.
EXAMPLEOption 2 is turned OFF for all channels
NOTESThis option is a detector wide setting. Changing it for one channel changes it for all channels. This option will automatically turn off 15 minutes after being activated or on loss of power.



PARAMETEROption 3 (Call Extension Control).
SETTINGS.....ON or OFF.
SETTING DISPLAYEDThe word ON or OFF will be displayed.
7 SEGMENT DISPLAYThe number of this option.
DEFAULT SETTING.....OFF for all channels.
EXAMPLE.....Option 3 is turned ON for channel 1.
NOTES.....Operation of this option requires that the Phase Green Inputs be correctly connected to the controller phase green circuitry.



PARAMETEROption 4 (Noise Filter Disable).
SETTINGS.....ON or OFF.
SETTING DISPLAYEDThe word ON or OFF will be displayed.
7 SEGMENT DISPLAYThe number of this option.
DEFAULT SETTING.....OFF for all channels.
EXAMPLE.....Option 4 is turned OFF for all channels.
NOTES.....This option is a detector wide setting. Changing it for one channel changes it for all channels. Changing the setting of this option will reset all detector channels. **It is recommended that this option be set to OFF for normal operation.**



PARAMETEROption 5 (Phase Green Loop Compensation).
SETTINGS.....ON or OFF.
SETTING DISPLAYEDThe word ON or OFF will be displayed.
7 SEGMENT DISPLAYThe number of this option.
DEFAULT SETTING.....OFF for all channels.
EXAMPLE.....Option 5 is turned ON for channel 1.
NOTES.....Operation of this option requires that the Phase Green Inputs be correctly connected to the controller phase green circuitry.

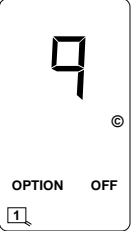

PARAMETEROption 9 (Third Car Passage).
SETTINGS.....ON or OFF.
SETTING DISPLAYEDThe word ON or OFF will be displayed.
7 SEGMENT DISPLAYThe number of this option.
DEFAULT SETTING.....OFF for all channels.
EXAMPLE.....Option 9 is turned OFF for channels 1 and 2.
NOTES.....This is a paired channel option. Channel 1 is paired with channel 2 and Channel 3 is paired with channel 4. Changing the setting for one channel also changes the setting for the paired channel. Turning ON Option 9 automatically turns OFF Option 10.

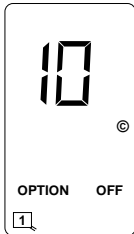

PARAMETEROption 10 (Directional Logic).
SETTINGS.....ON or OFF.
SETTING DISPLAYEDThe word ON or OFF will be displayed.
7 SEGMENT DISPLAYThe number of this option.
DEFAULT SETTING.....OFF for all channels.
EXAMPLE.....Option 10 is turned OFF for channels 1 and 2.
NOTES.....This is a paired channel option. Channel 1 is paired with channel 2 and Channel 3 is paired with channel 4. Changing the setting for one channel also changes the setting for the paired channel. Turning ON Option 10 automatically turns OFF Option 9.

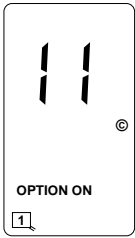

PARAMETEROption 11 (Audible Detect).
SETTINGS.....ON or OFF.
SETTING DISPLAYEDThe word ON or OFF will be displayed.
7 SEGMENT DISPLAYThe number of this option.
DEFAULT SETTING.....OFF for all channels.
EXAMPLE.....Option 11 is turned ON for channel 1.
NOTES.....This option is mutually exclusive with the same option on the other channels. Turning it ON for one channel turns it OFF for all other channels. This option will automatically turn OFF 15 minutes after being activated or on loss of power.



PARAMETEROption 12.0 (Detector Disconnect).
SETTINGS.....ON or OFF.
SETTING DISPLAYEDThe word ON or OFF will be displayed.
7 SEGMENT DISPLAYThe number of this option.
DEFAULT SETTING.....OFF for all channels.
EXAMPLE.....Option 12.0 is turned ON for channel 1.
NOTES.....When this option is turned ON, the value entered in Extension time is used as a Disconnect time. Operation of this option requires that the Phase Green Inputs be correctly connected to the controller phase green circuitry.



PARAMETEROption 12.1 (Detector Disconnect Type).
SETTINGS.....ON or OFF.
SETTING DISPLAYEDThe word ON or OFF will be displayed.
7 SEGMENT DISPLAYThe number of this option.
DEFAULT SETTING.....OFF for all channels.
EXAMPLE.....Option 12.1 is turned OFF for channel 1.
NOTES.....When this option is turned ON, the value entered in Extension time is used as a Disconnect time and no extension of the call is made. When Option 12.1 is turned OFF, Extension time is active. Extension time and Disconnect time function concurrently.



PARAMETERLoop Fail.
SETTINGS.....Pressing the ▲ (UP) or ▼ (DOWN) button will clear the Loop Fail memory.
SETTING DISPLAYEDView only.
7 SEGMENT DISPLAYLoop Failures since the last time it was cleared manually or due to power failure.
DEFAULT SETTING.....0 for all channels.
EXAMPLE.....There are eight (8) Loop Failures in the accumulator for channel 1.
NOTES.....Count will be reset to zero after loss of power, by pressing the ▲ (UP) or ▼ (DOWN) button, or by resetting the channel.

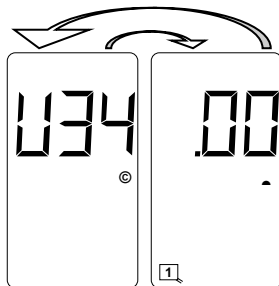

PARAMETERFirmware Version and Revision.
SETTINGS.....View Only.
SETTING DISPLAYEDView Only.
7 SEGMENT DISPLAYModel letter and firmware version on one screen and firmware revision on the other screen.
DEFAULT SETTING.....Not Applicable.
EXAMPLE.....Model U firmware version 34, revision .00.

5.2 NORMAL MODE DISPLAY SCREENS

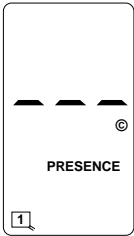

STATEIdle.
BARGRAPH DISPLAYOFF.
7 SEGMENT DISPLAYThree Dashes.
TEXTPULSE or PRESENCE indicating detection mode of the channel.

CHANNEL LEDOFF.
CHANNEL OUTPUTOFF.
EXAMPLEChannel 1 is idle and in the presence mode of detection.

NOTESThis is the normal state for the display when the loop detection zone is unoccupied and the channel does not have any timing options set.



STATEPresence Call.

BARGRAPH DISPLAYNumber of sensitivity levels that the inductance change caused by the vehicle exceeds the detection threshold (first dot = current sensitivity level, second dot = next lower sensitivity level, etc.).

7 SEGMENT DISPLAYCall.
TEXTPRESENCE, indicating detection mode of the channel.

CHANNEL LEDSolid ON.
CHANNEL OUTPUTON.

EXAMPLEChannel 1 detection zone is occupied by a vehicle that exceeds the detection threshold by four (4) sensitivity levels and channel 1 is outputting a call.

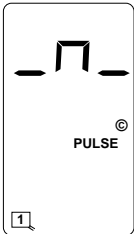

STATEPulse Call.

BARGRAPH DISPLAYOFF.
7 SEGMENT DISPLAY¹¹- for 125 milliseconds.

TEXTPULSE, indicating detection mode of the channel.

CHANNEL LEDON for 125 milliseconds.
CHANNEL OUTPUTON for 125 milliseconds.

EXAMPLEChannel 1 detection zone is occupied and channel 1 is outputting a call of 125 milliseconds duration.

NOTESThis display is only shown for 125 milliseconds (the duration of the pulse output).



STATETiming Delay.

BARGRAPH DISPLAYNumber of sensitivity levels that the inductance change caused by the vehicle exceeds the detection threshold (first dot = current sensitivity level, second dot = next lower sensitivity level, etc.).

7 SEGMENT DISPLAYCountdown of remaining Delay time (in seconds).

TEXTSECONDS, DELAY, and PULSE or PRESENCE.

CHANNEL LEDFour Hz flash rate with 50% duty cycle (125 ms ON, 125 ms OFF).

CHANNEL OUTPUTOFF.

EXAMPLEChannel 1 detection zone is occupied by a vehicle that exceeds the detection threshold by two (2) sensitivity levels, there are three (3) seconds of Delay remaining, and channel 1 is not outputting a call.



STATETiming Extension.

BARGRAPH DISPLAYOFF.

7 SEGMENT DISPLAYCountdown of remaining Extension time (in seconds).

TEXTSECONDS, EXTENSION, and PULSE or PRESENCE.

CHANNEL LED16.6 Hz flash rate with 50% duty cycle (30 ms ON, 30 ms OFF).

CHANNEL OUTPUTON.

EXAMPLEChannel 1 detection zone is vacant, there are two and one-half (2.5) seconds of Extension time remaining, and channel 1 is outputting a call.

NOTESWhen Option 12.0 is ON and 12.1 is OFF, the Extension timer becomes the Disconnect timer.



STATETiming Max Presence.
BARGRAPH DISPLAYNumber of sensitivity levels that the inductance change caused by the vehicle exceeds the detection threshold (first dot = current sensitivity level, second dot = next lower sensitivity level, etc.).
7 SEGMENT DISPLAYCountdown of remaining seconds of Max Presence.
TEXT.....SECONDS and MAX PRESENCE.
CHANNEL LED.....Solid ON.
CHANNEL OUTPUT.....ON.
EXAMPLE.....Channel 1 detection zone is occupied by a vehicle that exceeds the detection threshold by five (5) sensitivity levels, there are 30 seconds of Max Presence remaining, and channel 1 is outputting a call.



STATEMax Presence Timed Out and Waiting for End Of Green.
BARGRAPH DISPLAYNumber of sensitivity levels that the inductance change caused by the vehicle exceeds the detection threshold (first dot = current sensitivity level, second dot = next lower sensitivity level, etc.).
7 SEGMENT DISPLAY000 - Showing that the Max Presence timer has timed out.
TEXT.....SECONDS, MAX PRESENCE, and EOG (EOG will be flashing).
CHANNEL LED.....Solid ON.
CHANNEL OUTPUT.....ON.
EXAMPLE.....Channel 1 detection zone is occupied by a vehicle that exceeds the detection threshold by five (5) sensitivity levels, Max Presence has timed out and is waiting for the End Of Green, and channel 1 is outputting a call.



STATEPending.
BARGRAPH DISPLAYNumber of sensitivity levels that the inductance change caused by the vehicle exceeds the detection threshold (first dot = current sensitivity level, second dot = next lower sensitivity level, etc.).
7 SEGMENT DISPLAYPnd.
TEXT.....PULSE or PRESENCE indicating detection mode of the channel.
CHANNEL LED.....3.3 Hz flash rate with 83% duty cycle (250 ms ON, 25 ms OFF).
CHANNEL OUTPUT.....OFF.
EXAMPLE.....Channel 1 detection zone is occupied by a vehicle that exceeds the detection threshold by seven (7) sensitivity levels and channel 1 is not outputting a call. Either Option 9 (Third Car Passage), Option 10 (Directional Logic), or Option 12 (Detector Disconnect) has been selected.
NOTES.....The Pending state is used when the channel would normally output a call but is not, due to the operational functions of Options 9 (Third Car Passage), Option 10 (Directional Logic), or Option 12 (Detector Disconnect).



STATELoop Inductance Display (Option 1 ON).
BARGRAPH DISPLAYOFF if no vehicle is detected. Number of sensitivity levels that the inductance change caused by the vehicle exceeds the detection threshold (first dot = current sensitivity level, second dot = next lower sensitivity level, etc.) if a vehicle is detected.
7 SEGMENT DISPLAYLoop / Lead-In circuit inductance in microhenries. If the value exceeds 999, the display will alternate between the thousands place (1 or 2) and the lower three digits of the inductance value.
TEXT.....L=
CHANNEL LED.....The detect LED operates normally indicating call, no call, delay, extension, and/or pending as expected.
CHANNEL OUTPUT.....The channel output operates normally.
EXAMPLE.....Channel 1 Loop / Lead-In circuit inductance is 98 microhenries and channel 1 is not detecting a vehicle.
NOTES.....If Option 2 (-AL/L Display) is ON, this display is only visible when the channel is not detecting a vehicle.



STATELoop Inductance -Δ/L/L Display (% Change) (Option 2 ON).
BARGRAPH DISPLAYOFF.
7 SEGMENT DISPLAYPercentage of change in inductance of the Loop / Lead-In circuit.
TEXT.....-Δ/L/L.
CHANNEL LED.....The detect LED operates normally indicating call, no call, delay, extension, and/or pending as expected.
CHANNEL OUTPUT.....The channel output operates normally.
EXAMPLE.....Percentage change of inductance of the call on channel 1 is 0.087%.
NOTES.....This display is only visible while the channel is detecting a vehicle and not timing any functions.



STATELCD Test.
BARGRAPH DISPLAYAll segments on.
7 SEGMENT DISPLAYAll segments on.
TEXT.....All segments on.
CHANNEL LED.....The detect LED operates normally indicating call, no call, delay, extension, and/or pending as expected.
CHANNEL OUTPUT.....The channel output operates normally.
EXAMPLE.....All segments on.
NOTES.....This display is visible whenever two or three pushbutton switches are pressed at the same time.

5.3 LOOP FAIL INDICATIONS

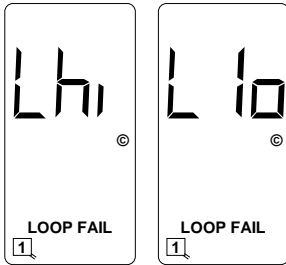

+25% change or open loop condition.

-25% change or shorted loop condition.

If the total inductance of a channel's loop input network goes out of the range specified for the detector, or rapidly changes by more than $\pm 25\%$, the channel will enter the Fail-Safe mode and LOOP FAIL will be displayed on the LCD. The type of loop failure will also be displayed as **L lo** (for -25% change or shorted loop conditions) or **L hi** (for +25% change or open loop conditions). This will continue as long as the loop fault exists. Fail-Safe mode generates a continuous call in Presence Mode and in Pulse Mode. At the time of a loop failure, the channel's LED will begin to flash at a rate of three flashes per second. The LED will continue this display pattern until the channel is manually reset or power is removed.

If the loop self-heals, the LOOP FAIL message on the LCD will extinguish and the channel will resume operation in a normal manner; except, the LED will continue the three flashes per second display pattern, thus, providing an alert that a prior Loop Fail condition has occurred. Each loop failure is counted and accumulated into the Loop Fail Memory. The total number of loop failures for the channel is written

into the Loop Fail Memory (since the last power interruption or manual reset) and can be seen by stepping through the channel's functions in Program Mode to the LOOP FAIL display.

This is a useful tool to identify intermittent loop problems. If the count is extremely high for the period of time observed, the problem is very likely a loose connection (check for loose connections at the terminal strip and bad splices in the field). The Loop Fail Count is reset when power is removed from the detector. This prevents the Loop Failure Count from moving to another loop, if the detector is moved to a new location.

To view the Loop Fail Count, repeatedly press the FUNC button until the LOOP FAIL display is shown. The Loop Fail Count display is after the OPTION displays. Pressing the ▲ (UP) or ▼ (DOWN) button while the Loop Fail Count is displayed will reset the count to zero.

NOTE: The Loop Fail Count is not reset when the setting of Option 4 (Noise Filter Disable) is changed or when the channel's sensitivity or frequency is changed. The prior Loop Fail indication will continue until the Loop Fail Count is reset to zero.

5.4 SETTING SENSITIVITY USING THE BARGRAPH

The bargraph is a graphical representation of the relative change of inductance as seen by the channel. It automatically takes into account the channel's sensitivity setting, loop geometry, configuration, lead-in length, etc. The first bar segment represents the minimum inductance change (set by the sensitivity level) necessary for the channel to output a call. Each additional segment to the right represents the inductance change in excess of the next sensitivity threshold. Usually, the larger the vehicle, the greater the $-\Delta L/L$; thus, more and more segments are displayed. The bargraph can be used as a precise indicator to select the proper sensitivity level.

The bargraph below shows the deflection (3 segments) of a vehicle with Sensitivity set to Level 4. The vehicle in the loop zone is causing a change of inductance greater than 0.32% $-\Delta L/L$ or Sensitivity Level 2.

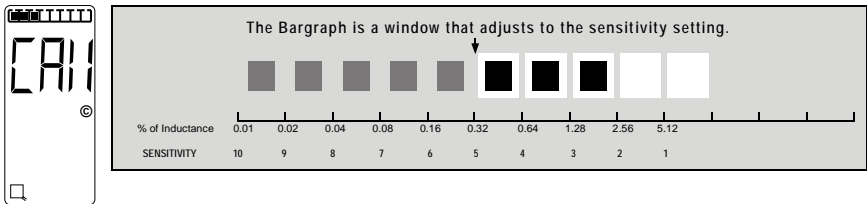

The bargraph below has the same vehicle in the loop zone causing the same inductance change as above. Since the sensitivity setting was increased to Level 7, six segments are now displayed. If the bargraph displays 5 or 6 segments for a vehicle in the loop and motorcycles are not a concern, the sensitivity has been set to the proper range.

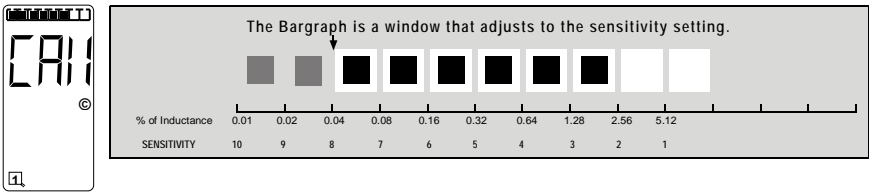

5.5 SETTING SENSITIVITY FOR MOTORCYCLE DETECTION USING THE BARGRAPH

The bargraph can also be used to select the proper sensitivity level for small motorcycle detection. The relative change of inductance caused by a motorcycle and a single automobile are proportional on any loop configuration. Selecting the sensitivity level that causes the bargraph to display the seventh segment for a single standard automobile automatically sets the sensitivity to detect small motorcycles. Follow the steps below:



Step 1: Observe a single standard automobile in the loop zone. Note the number of segments displayed on the bargraph. (4)

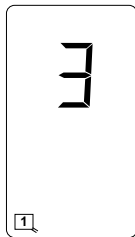

Step 2: Go to the Program mode. Note the sensitivity level. (3)

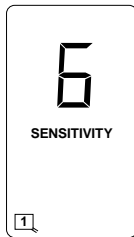

Step 3: Subtract the actual number of segments displayed from the desired number of 7. ($7 - 4 = 3$) Increase the sensitivity three levels.

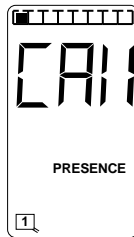

Step 4: Verify that a single standard automobile causes the bargraph to move seven segments.



Step 5: A small motorcycle should be detected causing a one segment deflection.

Note: This method applies to conventional loop configurations only. Other loop configurations, such as Quadrupole™, will require a different method to correctly set sensitivity for motorcycle detection. Increasing the sensitivity to detect motorcycles in some loop configurations will make the loop sensitive to adjacent lane detection. If adjacent lane traffic is detected, the phase will max time when no vehicles are present in the loop (see Option 5 - Phase Green Loop Compensation for a possible solution).

5.6 FULL RESTORE TO FACTORY DEFAULT SETTINGS

Pressing all four front panel switches simultaneously and continuously for five (5) seconds resets the detector and restores all the factory default settings. The countdown of the five second period is displayed on the LCD. Releasing any of the switches before the countdown ends aborts the Full Restore operation. (See Section 3.5 for default settings.)

5.7 DISPLAY TEST

Pressing any two or three of the front panel switches simultaneously will turn on all possible symbols and messages on the LCD.

Section 6 Block Diagram

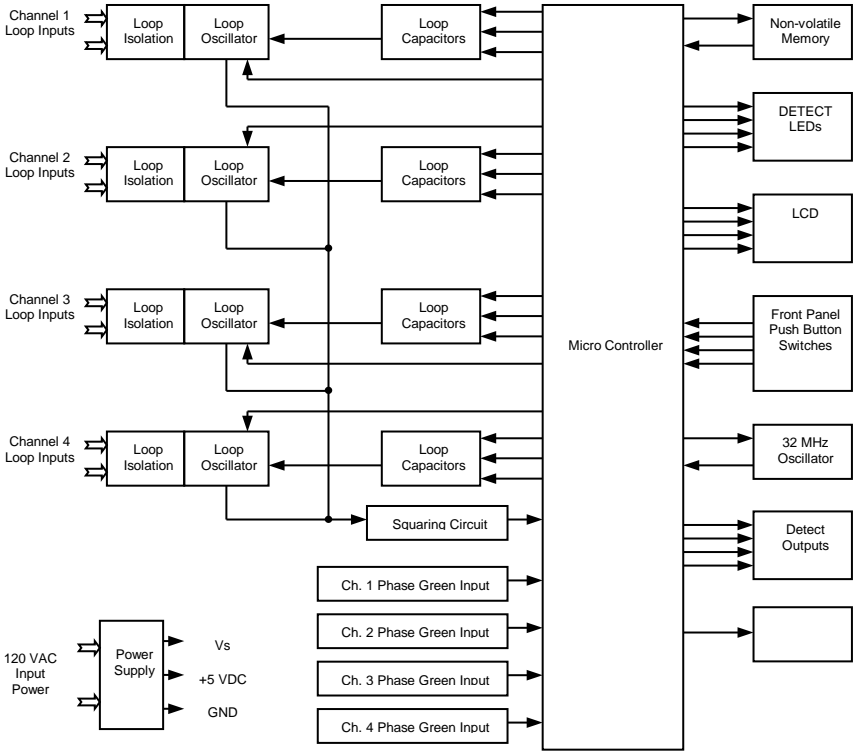

Section 7 Theory of Operation

The Reno A & E Model U-1000 detector digitally measures changes in the resonant frequency of four independent loop circuits to determine if a vehicle has entered the detection zone. The Model U-1000 Series detector applies an excitation voltage to each loop circuit resulting in the loops oscillating at their resonant frequency. The current flow in the loop wire creates magnetic fields around the loop wire. When a vehicle passes over the loop area, the conductive metal of the vehicle causes a loading of the loop's magnetic fields. The loading decreases the loop inductance, which causes the resonant frequency to increase. By continuously sampling the loop's resonant frequency, the magnitude and rate of change can be determined. If the frequency change exceeds a selectable threshold (set by the sensitivity settings), the channel will activate an output signal. If the rate of change is slow, typical of environmental drift, the channel will continuously track and compensate for the change. The Model U-1000 detector also monitors the loop frequency for out of range conditions such as an open or shorted loop circuit.

The Model U-1000 detector is a scanning detector. The scanning method sequentially turns each channel's loop oscillators on and off. Each channel's oscillator circuit supplies the excitation voltage that is coupled to the loop circuit by a loop isolation transformer. The channel's oscillator circuit supplies the excitation voltage that is coupled to the loop circuit by a loop isolation transformer. The transformer provides high common mode isolation between the loop and detector electronics, which allows the channel to operate on poor quality loops including a single short to ground. The transformer also limits the amount of static energy (lightning) that can transfer to the detector electronics. A spark gap transient suppression device is connected across the loop inputs connected to the isolation transformer. This device dissipates static charges before they reach the transformer. A network of four capacitors is connected to the detector side of the isolation transformer. Three of the capacitors can be switched in or out of the oscillator circuit to shift the frequency of the loop oscillator circuit thus providing frequency separation between adjacent loops. The three switchable capacitors are electronically switched using FETs and are selected when programming parameter values with the front panel pushbutton switches.

The outputs from the four loop oscillators are tied together and fed into a common squaring circuit. This is possible since the detector is a scanning detector that allows only a single loop oscillator to be operating at any given time. The sine wave from the loop oscillator circuit is squared to provide a precise zero crossing signal for the input to the microcontroller. This signal is called the loop sample. The loop sample is an integral number of complete oscillations from the loop oscillator circuit. The number of loop oscillations counted is a function of the selected sensitivity setting for the channel. The required number of loop oscillations needed for a loop sample increases as the sensitivity setting is increased. The microcontroller uses the period of the loop sample for accumulating high-speed (32 MHz) crystal clock pulses generated by the microcontroller's internal high-speed crystal oscillator. The number of crystal clock pulses accumulated during consecutive loop samples is compared to the internal reference number of crystal clock pulses stored in the microcontroller's memory.

When a vehicle enters the loop zone the loop inductance decreases. This decrease in loop inductance causes an increase in the loop oscillator frequency. In turn, an increase in loop oscillator frequency results in a decrease of the time period for the loop sample. Hence, when a vehicle enters the loop zone the number of crystal clock pulses accumulated during a loop sample period decreases. By comparing the new count with the reference count, a percentage change can be calculated that indirectly relates to the inductance change. If the magnitude of the change exceeds a selectable threshold (sensitivity setting), the channel activates an output device. The rate of change is also monitored. Slow rates of change caused by environmental fluctuations are tracked and automatically compensated for.

The microcontroller uses the high-speed crystal clock count to calculate the loop inductance, frequency and percentage of change. If selected, the values are displayed on the seven segment LCD. The microcontroller also processes the pushbutton switch selections for the LCD and stores the operating parameters in non-volatile memory. Stored parameters are only changed with the front panel switches and are unaffected by loss of power or channel reset. The microcontroller continuously processes the loop samples and the detector operation is not affected during the operation of the switches or the LCD. (Note: When either channel's sensitivity or frequency is changed, that channel is reset.)

In addition, the microcontroller conditions the outputs based on Phase Green Inputs and the programmed settings of the various timers (Delay, Extension, and Max Presence) and options (EOG, Option 3, Option 4, Option 5, Option 9, Option 10, and Option 12).

Section 8 Maintenance and Troubleshooting

The Reno A & E Model U-1000 Detector requires no maintenance. If you are having problems with your Model U-1000 detector, use the troubleshooting chart below to help determine the cause of the problem.

| Symptom | Where To Start |
|--|---|
| No LCD display and no LEDs lit. | See Troubleshooting Power Problems . |
| LCD displays garbage and detector does not respond to button presses. | See Troubleshooting Initialization Problems . |
| Detector does not respond to button presses. | See Troubleshooting Initialization Problems . |
| LCD continually displays <i>L lo</i> and <i>Loop Fail</i> or <i>L hi</i> and <i>Loop Fail</i> . | See Troubleshooting Loop Fail Problems . |
| The channel detect LED is flashing three times per second and channel appears to be working correctly. | See Troubleshooting Intermittent Loop Fail Problems . |
| Detector intermittently stays in the Call state. | See Troubleshooting Intermittent channel Lock Ups . |
| A channel will not time delay. | See Troubleshooting Delay Problems . |
| A channel does not always time delay. | See Troubleshooting Delay Problems . |
| LCD displays <i>Pnd</i> and a channel does not output a call. | One of the paired channel options (Option 9 or 10) or detector disconnect (Option 12.0) has been turned on. |
| A channel does not always time extension. | Option 3 is on. |
| Max Presence never resets the channel. | EOG is turned on and the Phase Green Input for the channel is not transitioning from green to not green. |
| LCD always displays a flashing <i>Call</i> . | The sensitivity for the channel has been set to Call forcing the channel to output a constant call. |

8.1 TROUBLESHOOTING POWER PROBLEMS

Does the LCD display anything when the detector is powered up?

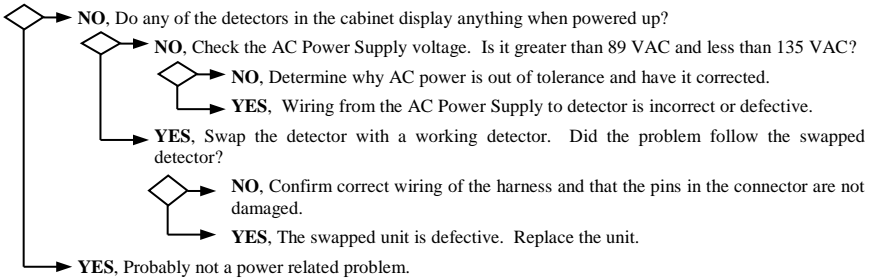

8.2 TROUBLESHOOTING INITIALIZATION PROBLEMS

Does the LCD display the Model and Firmware version when powered up?

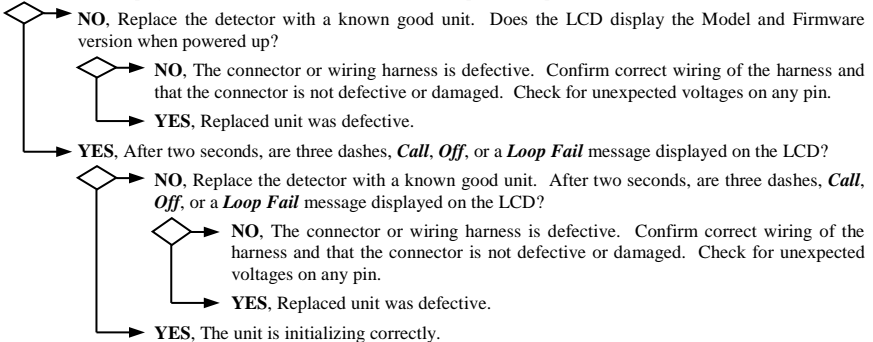

8.3 TROUBLESHOOTING LOOP FAIL PROBLEMS

Check each channel's status by momentarily pressing the CHAN button to step through the channels. Do any of the channels display *L hi* and *Loop Fail*?

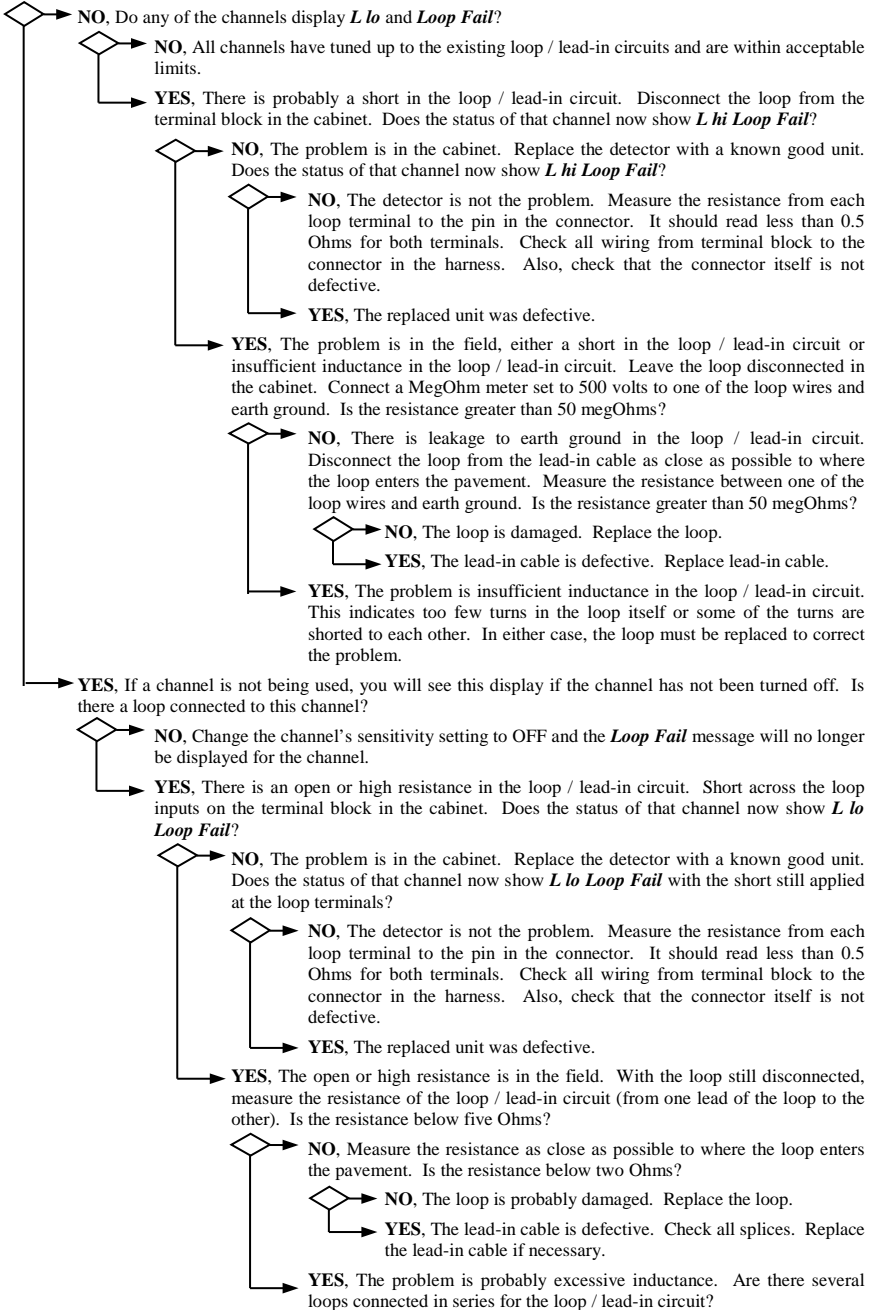

- NO, This is typically caused by having too many turns in a large loop. Replace the loop with one that has an inductance of less than 2000 microhenries.
- YES, If possible, connecting each loop to its own channel is preferred. Or try a parallel wiring arrangement for the loops if separate detection channels are not possible.

8.4 TROUBLESHOOTING INTERMITTENT LOOP FAIL PROBLEMS

Have you been able to see the channel display while the loop failure was occurring?

- NO, Loop Fail problems tend to be bad splices in the loop / lead-in circuit, shorts in the loop / lead-in circuit, shorts to earth ground in the loop / lead-in circuit, or loose connections or bad solder joints in the signal cabinet. If you have any splices that are not soldered and sealed with an adhesive heat shrink or epoxy resin, replace the splice with one that is. Using a MegOhm meter, measure the resistance from one of the loop wires to earth ground. It should be greater than 50 megOhms. Inspect the loop. Look for exposed wires or debris pressed into the saw cut. Tighten all screw terminals in the signal cabinet that the loop circuit uses. Check solder joints in the loop circuit, especially on the harness itself. Disconnect and reconnect any connector used in the loop circuit and check for loose pins and sockets in these connectors. If your cabinet has lightning or surge suppression devices on the loop inputs in the cabinet, remove or replace them. Check for places in the field where the loop wire or lead-in cable may be pinched or chaffed. Look for wires pinched under junction box covers and where the wire enters a conduit, especially where the loop wire leaves the saw cut and enters a conduit. After checking all of the above items, you could swap out the detector but this type of failure is rarely ever related to the detector.

YES, Did the display show *L hi*?

- NO, The display must have been *L lo* then. This indicates an intermittent shorted loop or -25% inductance change. Using a MegOhm meter, measure the resistance from one of the loop wires to earth ground. It should be greater than 50 megOhms. Inspect the loop. Look for exposed wires or debris pressed into the saw cut. Check for places in the field where the loop wire or lead-in cable may be pinched or chaffed. Look for wires pinched under junction box covers and where the wire enters a conduit, especially where the loop wire leaves the saw cut and enters a conduit. **If your cabinet has lightning or surge suppression devices on the loop inputs in the cabinet, remove or replace them.**
- YES, This indicates an intermittent open loop or +25% inductance change. If you have any splices that are not soldered and sealed with an adhesive heat shrink or epoxy resin, replace the splice with one that is. Tighten all screw terminals in the signal cabinet that the loop circuit uses. Check solder joints in the loop circuit, especially on the harness itself. Disconnect and reconnect any connector used in the loop circuit and check for loose pins and sockets in these connectors.

8.5 TROUBLESHOOTING INTERMITTENT DETECTOR LOCK-UPS

Have you been able to see the channel display while the loop was locked up?

- NO, See **Troubleshooting Intermittent Loop Fail Problems** and follow the path for unable to see the channel display while the loop failure was occurring.

YES, Were more than two segments lit in the bargraph on the LCD?

- NO, Problems of this type tend to be difficult to isolate due to the many possible causes and the short duration of the symptom (usually less than 30 minutes). If the problem occurs more frequently in the morning or when raining, suspect a short to earth ground in the loop / lead-in circuit. This can usually be verified by testing with a MegOhm meter but not always. Vibration can also be a possible cause. Loop wires may be moving slightly in a conduit due to vibrations from truck traffic. Utility lids in the street near the loop may also be a source of problems. Ensure that lids near a loop are bolted down so that they cannot move. Check that each set of loop wires is twisted together in each pull box and that lengths are not excessive. And also see **Troubleshooting Intermittent Loop Fail Problems** and follow the path for a loop failure that displays *L lo* on the LCD.
- YES, See **Troubleshooting Intermittent Loop Fail Problems** and follow the path for a loop failure that displays *L lo* on the LCD.

8.6 TROUBLESHOOTING DELAY PROBLEMS

Does the channel ever time the Delay function?

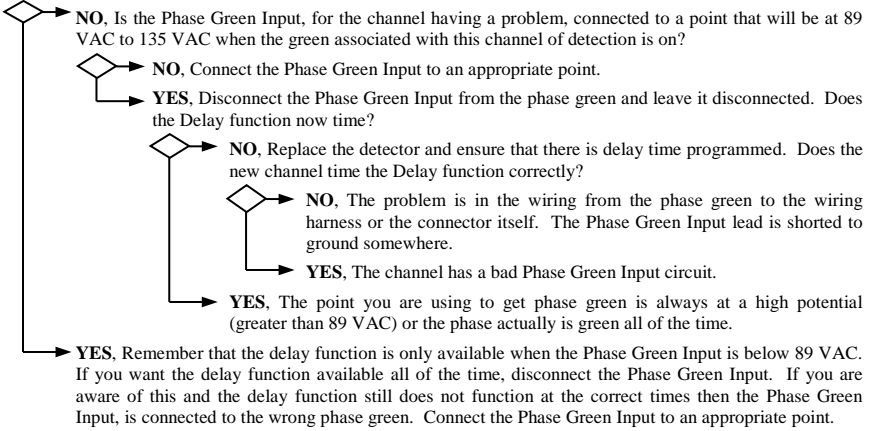

8.7 THINGS TO KNOW ABOUT LOOPS

Always use a wire with cross-linked Polyethylene insulation (insulation type XLPE) for loop wire.

Typical sensing height is $\frac{2}{3}$ of the shortest leg of a loop. Therefore, a 6' x 6' loop will have a detection height of 4'.

The inductance of a conventional four-sided loop can be estimated using the formula:

$$L = P \times (T^2 + T) / 4$$

Where: L = Loop Inductance in microhenries
P = Loop Perimeter in feet
T = Number of Turns of Wire.

Therefore, a 6' by 6' loop with 3 turns would have an inductance of:

$$\begin{aligned} L &= (6 + 6 + 6 + 6) \times (3^2 + 3) / 4 \\ L &= 24 \times (9 + 3) / 4 \\ L &= 24 \times 12 / 4 \\ L &= 24 \times 3 \\ L &= 72 \text{ microhenries.} \end{aligned}$$

The inductance of a Quadrupole™ loop can be estimated using the formula:

$$L = [P \times (T^2 + T) / 4] + [CL \times (T^2 + T) / 4]$$

Where: L = Loop Inductance in microhenries
P = Loop Perimeter in feet
T = Number of Turns of Wire
CL = Length of Center Leg in feet.

Therefore, a 6' by 50' loop with a 2-4-2 configuration would have an inductance of:

$$\begin{aligned} L &= [(6 + 50 + 6 + 50) \times (2^2 + 2) / 4] + [50 \times (4^2 + 4) / 4] \\ L &= [112 \times (4 + 2) / 4] + [50 \times (16 + 4) / 4] \\ L &= (112 \times 6 / 4) + (50 \times 20 / 4) \\ L &= (112 \times 1.5) + (50 \times 5) \\ L &= 168 + 250 \\ L &= 418 \text{ microhenries.} \end{aligned}$$

Loop Feeder cable typically adds 0.22 microhenries of inductance per foot of cable.

Total inductance of loops connected in series:

$$L_{\text{TOTAL}} = L_1 + L_2 + L_3 + \dots + L_N$$

Total inductance of loops connected in parallel:

$$L_{\text{TOTAL}} = 1 / [(1 / L_1) + (1 / L_2) + (1 / L_3) + \dots + (1 / L_N)]$$