

Model G & Model 222-1 Series

Operations Manual

Two Channel DIP Switch Programmable Inductive Loop Vehicle
Detector

This manual contains technical information for the
Model G & Model 222-1 Series Loop Detector

pn 889-0709-00 Revision: April 2020



THE FOLLOWING PRODUCT WAS DESIGNED, INSPECTED, TESTED AND
MANUFACTURED IN THE USA BY EBERLE DESIGN, INC. IN PHOENIX, ARIZONA.
INFORMATION CONTAINED HEREIN IS PROPRIETARY TECHNICAL INFORMATION OF
EBERLE DESIGN, INC. PUBLICATION, REPRODUCTION OR USE IN WHOLE OR PART IS
NOT PERMITTED EXCEPT UNDER TERMS AGREED UPON IN WRITING. ALL
REGISTERED TRADEMARKS OF EBERLE DESIGN INC. ARE UNDER
© COPYRIGHT

MAINTENANCE NOTE

**IT IS AN EBERLE DESIGN, INC. RECOMMENDATION THAT EACH UNIT BE TESTED
AT LEAST ANNUALLY TO ENSURE COMPLIANCE WITH FACTORY
SPECIFICATIONS AND MEETS PROPER OPERATIONAL STANDARDS. THE
RESULTS OF THIS TESTING WILL BE DOCUMENTED.**

Model G & Model 222-1 Series

Operations Manual

Table of Contents

Section 1 General Description	1
Section 2 General Characteristics	2
2.1 Loop Frequency	2
2.2 Sensitivity.....	2
2.3 Presence/Pulse Mode	2
2.4 Fail-Safe / Fail-Secure.....	2
2.5 Disable Channel.....	2
2.6 100ms Minimum Output	2
Section 3 Specifications	2
3.1 Physical.....	3
3.2 Electrical	3
3.3 Operational	3
3.4 TABLE: Sensitivity, $\Delta L/L$, & Typical Response Times.....	3
3.5 TABLE: Default Settings.....	4
3.6 TABLE: Pin Assignments	5
Section 4 User Interface	6
Section 5 Installation and Set-Up	7
5.1 Front Panel Programming DIP Switches.....	7
5.2 Loop Fail Indications	8
5.3 Resetting the Detector.....	8
Section 6 Block Diagram	9
Section 7 Theory of Operation	10
Section 8 Maintenance and Troubleshooting	10
8.1 Troubleshooting Power Problems.....	12
8.2 Troubleshooting Loop Fail Problems	12
8.3 Troubleshooting Intermittent Loop Fail Problems.....	13
8.4 Troubleshooting Intermittent Detector Lock Ups	14
8.5 Test Mode Operation.....	14
8.6 Voltage & Waveform Measurements	15
8.7 Things to Know About Loops.....	15

Section 1 General Description

This Product Manual was written for people installing, operating, and troubleshooting Reno A&E Model G and Model 222-1 inductive loop vehicle detectors. Both are scanning, two channel, card rack type loop detectors. The Model G is designed to meet or exceed the NEMA Standards TS 2-1992 and is downward compatible to NEMA Standards TS 1-1989. The Model 222-1 is a version of the Caltrans approved Model 222 except that the FAIL-SAFE / FAIL-SECURE switch has been disabled and defaulted for Fail-Safe operation.

Both models use a microcontroller to monitor and process signals from two separate loop/lead-in circuits. The operation of each channel is independently programmed with a front panel eight-position DIP switch to provide the following selections:

- 8 Sensitivity Levels %(- Δ L/L)
- Presence or Pulse Mode
- Fail-Safe or Fail-Secure in a loop fail condition (not available on Model 222-1)
- 4 Frequency Selections
- Channel Disable

The FAILSAFE/FAILSECURE switch selects the channel output state as "CALL" or "NO CALL" during a loop failure condition. The FAIL-SAFE selection, which is the standard for intersection control, generates a continuous "CALL" output state for as long as a loop failure condition exists. The FAIL-SECURE selection generates a "NO CALL" output state during a loop failure condition. Traffic control applications such as incident detection prefer the Fail-Secure operation, because a constant "CALL" from a failed loop appears as though the traffic movement has stopped. The FAIL-SECURE selection also selects faster response times for very accurate speed measurement. The switch selection allows the user to set the detector operation for the application.

The Model 222 alternately excites the two loop circuits. This eliminates adjacent loop fields from coupling together (crosstalk) when the loops are connected to the same detector. Each time the loop circuit is activated, loop data is obtained and recorded. The data is compared to previous samples for the amount and rate of change. A slow rate of change, as is the case with environmental drift, is continuously tracked. If a rapid change exceeds a threshold set by the sensitivity level, the output is activated.

If the total inductance of the loop input network goes out of the range specified for the detector, or rapidly changes by more than $\pm 25\%$, the channel will enter the programmed FAIL-SAFE or FAIL-SECURE mode of operation. The FAIL LED will turn ON and remain ON for as long as the loop fault exists. If the loop "self heals", the channel will resume operation in a normal manner; except the FAIL LED will begin a burst of 3 flashes a second, thus providing an alert that a Loop Fail condition has occurred. The FAIL LED will continue flashing indicating the prior loop failure condition until the detector is manually reset or power is removed. The Model G has TS-2 channel status outputs to communicate the status states of the loop and detector channel.

In addition, the Reno A&E Model G and 222-1 have a Test Mode that thoroughly tests the detector module without the external test equipment. The Test Mode uses the microcontroller to verify the proper operation of the entire detector's input and output circuitry including switches, LEDs and outputs. Each channel's loop oscillator circuit can also be tested to verify the correct frequency range in each of the 4 frequency selections.

The Model G/222 Series is comprised of the following detectors:

Model G-200-R	For applications needing a two channel, NEMA TS2 rack mount detector with relay outputs
Model G-200-SS	For applications needing a two channel, NEMA TS2 rack mount detector with solid state outputs
Model 222-1	For applications needing a two channel, 332 (170 Controller) rack mount detector with solid state outputs and Fail Safe only

Section 2 General Characteristics

2.1 LOOP FREQUENCY

There are four (4) selectable loop frequency settings (normally in the range of 20 to 100 kiloHertz) for each channel. The actual loop operating frequency is a function of the loop/lead-in network and the components of the loop oscillator circuit. Adjacent loops connected to different detectors may crosstalk and require changing of the operating frequency of one of the loop circuits. If crosstalk is a problem, select another loop frequency for stable operation. The four frequency selections for each channel are controlled with two switches marked 2 and 3 on the DIP switch. NOTE: The detector must be reset after changing the frequency setting.

2.2 SENSITIVITY

There are eight (8) selectable sensitivity levels for each channel. The sensitivity levels are designed so that a one level increase actually doubles the sensitivity and a one level decrease halves the sensitivity. The eight sensitivity levels are selected with three switches marked 6, 7, and 8 on the DIP switch for each channel. NOTE: Changing the sensitivity level setting will reset the detector.

Level	0	1	2	3	4	5	6	7
-ΔL/L	1.28%	0.64%	0.32%	0.16%	0.08%	0.04%	0.02%	0.01%

2.3 PRESENCE/PULSE MODE

Two modes of operation for each channel of the detector are available. Presence or Pulse mode is selected by setting the state of DIP switch 5 for each channel.

PRESENCE MODE: Provides a Call hold time of at least 4 minutes (regardless of vehicle size) and typically 1 to 3 hours for an automobile or truck. This is the factory default setting and the most common setting.

PULSE MODE: An output Pulse of 125 ± 10 milliseconds duration is generated for each vehicle entering the loop detection zone. Each detected vehicle is instantly tuned out if it remains in the loop detection zone longer than 2 seconds. This enables detection of subsequent vehicles entering the loop detection zone. After each vehicle leaves the loop detection zone, the channel resumes full sensitivity within 1 second. NOTE: Changing the MODE switch will RESET the channel.

A minimum 100ms presence output time can be selected by setting DIP switch 2 of "SW3" (located behind the front panel) to the "ON" position. In the "OFF" position, the presence time reflects the actual time the vehicle is over the loop.

2.4 FAIL-SAFE / FAIL-SECURE

The Fail-Safe or Fail-Secure mode of operation is selectable for each channel using DIP switch 4. This feature is only available on the Model G. This switch is disabled and defaulted to Fail-Safe operation on the Model 222-1.

During a loop failure condition, the state of the channel's output can be selected as "CALL" in the Fail-Safe mode of operation or "NO CALL" in the Fail-Secure mode of operation. Fail-Safe operation during a loop failure is the standard operation for intersection control. Fail-Secure operation during a loop failure is typically used for incident detection systems for freeway management. The Fail-Secure selection also selects fast response for very accurate speed and occupancy measurements (see Response Times). NOTE: Changing this setting will RESET the channel.

2.5 DISABLE CHANNEL

Each Channel in the detector can be disabled by setting DIP switch 1 to the ON condition. When set to the ON position, the channel output is continuously in the NO-CALL state regardless of the presence or absence of vehicles over the loop. The loop oscillator is not activated when the channel is in the "Disabled State". NOTE: Changing this setting will RESET the channel.

2.6 100MS MINIMUM OUTPUT

Two modes of operation are available for the CALL outputs of the detector when operating in the presence mode. Normal mode and 100ms Minimum Output mode are selected by setting DIP switch 2 on the two position DIP switch behind the front panel. When DIP switch 2 is in the OFF position, the CALL outputs stay on only as long as the detection zone is occupied. When DIP switch 2 is in the ON position, every CALL output will have a minimum duration of 100ms. This feature is used to insure that CALLs output by the detector will be seen by the controller. Some controllers do not check the detector outputs often enough to catch very short detection events (<100ms). So this feature will cause all detection events less than 100ms long to be 100ms long.

Section 3 Specifications

3.1 PHYSICAL

WEIGHT: 6.0 oz. (170 gm.)

SIZE: 4.50 inches (11.43 cm.) high x 1.12 inches (2.84 cm.) wide x 6.875 inches (17.46 cm.) long including connector.

OPERATING TEMPERATURE: -40°F to +180°F (-40°C to +82°C)

CIRCUIT BOARD: Printed circuit boards are 0.062in. FR4 material with 2 oz. copper on both sides and plated through holes. Circuit board and components are conformal coated with polyurethane.

CONNECTOR: 2 x 22 pin edge card connector with 0.156 inch (0.396 cm.) contact centers. Key slots located between B & C, E & F, and M & N. See section 3.6 for pin assignments.

LOOP FEEDER LENGTH: Up to 5000 feet (1500m.) maximum with proper feeder cable and appropriate loops.

3.2 ELECTRICAL

POWER: 10.8 to 30 VDC. Solid State output version – 100ma max. Relay version – 130ma max.

LOOP INDUCTANCE RANGE: 20 to 2000 microHenries with a Q factor of 5 or greater.

LOOP INPUTS: Transformer isolated. The minimum capacitance added by the detector is 0.068 microFarad.

LIGHTNING PROTECTION: The detector can tolerate, without damage, a 10 microFarad capacitor charged to 2,000 volts being discharged directly into the loop input terminals, or a 10 microFarad capacitor charged to 2,000 volts being discharged between either loop terminal and earth ground.

RESET: Each detector channel can be manually reset by momentarily changing any switch position (except the frequency switches). The detector is also reset by connecting a logic ground signal to pin C of the card edge connector or the return of power after a power loss.

RELAY RATING: The relay contacts are rated for 6 Amps max, 150 VDC max, and 180 Watts max. switched power.

SOLID STATE OUTPUT RATING (optional): Optically coupled transistors. 30 VDC max. collector to emitter. 50 mA max. saturation current. 1.2 VDC max. transistor saturation voltage. The output is protected with a 33-volt zener diode connected between the collector and emitter.

3.3 OPERATIONAL

DETECT INDICATORS: The detector has a super high intensity red light emitting diode (LED) per channel to indicate a CALL output.

LOOP FAIL INDICATOR: The detector has a super high intensity red light emitting diode (LED) per channel to indicate the status of any current or prior loop fault condition. A continuous ON state indicates a current loop fail condition. A burst of three flashes once per second indicates a prior loop fail condition.

RESPONSE TIME: Meets or exceeds NEMA TS 1 response time specifications. (See Table, “Sensitivity, $-\Delta L/L$, & Typical Response Times” for actual response times).

SELF-TUNING: The detector automatically tunes and is operational within 2 seconds after application of power or after being reset. Full sensitivity and hold time require 30 seconds of operation.

ENVIRONMENTAL & TRACKING: The detector is fully self-compensating for environmental changes and loop drift over the full temperature range and the entire loop inductance range.

GROUNDING LOOP OPERATION: The loop isolation transformer allows operation with poor quality loops (which may include one short to ground at a single point).

LOOP (FAIL) MONITOR: If the total inductance of the channel’s loop input network goes out of the range specified for the detector, or rapidly changes by more than $\pm 25\%$, the channel will immediately enter the programmed Fail-Safe or Fail-Secure mode of operation. The Fail-Safe mode of operation generates a continuous call during the loop failure. The Fail-Secure mode of operation does not generate a call during the loop failure. In both modes of operation, the FAIL LED will turn ON and remain on for as long as the loop fault exists. If the loop “self heals”, the channel will resume operation in a normal manner except that the FAIL LED will begin a burst of three flashes

once every second, thus providing an alert that a Loop Fail condition has occurred. The FAIL LED will continue flashing indicating the prior loop failure condition until the detector is manually reset or power is removed.

FAIL-SAFE OUTPUTS: Per NEMA TS 2 - conducting state indicates detection output. Each detector channel output defaults to a CALL state for any loop failure condition or loss of power.

CHANNEL STATUS OUTPUTS: Per NEMA TS 2 - Each channel has an output to communicate the status states of the channel as follows:

State	Status Output
Normal operation	Continuous Low or On State
Detector failure	Continuous High or Off State
Open loop	50 millisecond On time, 50 millisecond Off time
Shorted loop	50 millisecond On time, 100 millisecond Off time
Excessive inductance change ($\pm 25\%$)	50 millisecond On time, 150 millisecond Off time

3.4 TABLE: SENSITIVITY, $-\Delta L/L$, & TYPICAL RESPONSE TIMES

Sensitivity Level	Industry Reference	DIP SW 6	DIP SW 7	DIP SW 8	$-\Delta L/L$ Threshold	Fail-Secure Response Time	Fail-Safe Response Time
0		OFF	OFF	OFF	1.28%	1 \pm 1 ms.	20 \pm 20 ms.
1	Low	ON	OFF	OFF	0.64%	1 \pm 1 ms.	20 \pm 20 ms.
2		OFF	ON	OFF	0.32%	1 \pm 1 ms.	20 \pm 20 ms.
3	Normal	ON	ON	OFF	0.16%	2 \pm 2 ms.	20 \pm 20 ms.
4		OFF	OFF	ON	0.08%	4 \pm 4 ms.	20 \pm 20 ms.
5	High	ON	OFF	ON	0.04%	8 \pm 8 ms.	20 \pm 20 ms.
6		OFF	ON	ON	0.02%	16 \pm 16 ms.	20 \pm 20 ms.
7		ON	ON	ON	0.01%	32 \pm 32 ms.	20 \pm 20 ms.

To achieve the response times listed above, the Sensitivity and Fail-Safe/Fail-Secure settings for both channels must be set the same.

3.5 TABLE: DEFAULT SETTINGS

DIP Switch	Function	Setting	Position
1	Disable	OFF	OFF
2	Frequency	1	ON
3			OFF
4	Fail-Safe/Fail-Secure	Fail-Safe	ON
5	Presence/Pulse Mode	Presence	OFF
6	Sensitivity	4	OFF
7			OFF
8			ON

3.6 TABLE: PIN ASSIGNMENTS
1200 Series - NEMA

1100 Series - 332/170

SOLID STATE OUTPUTS

Pin	Function
A	D.C. (-) Common
B	D.C. (+) Power
C	Reset Input
D	Ch. 1 Loop Input
E	Ch. 1 Loop Input
F	Ch. 1 Output, Drain
H	Ch. 1 Output, Source
J	Ch. 2 Loop Input
K	Ch. 2 Loop Input
L	Chassis Ground
M	No Connection
N	No Connection
P	No Connection
R	No Connection
S	No Connection
T	No Connection
U	No Connection
V	No Connection
W	Ch. 2 Output, Drain
X	Ch. 2 Output, Source
Y	No Connection
Z	No Connection

Pin	Function
1	Ch. 1 - Phase Green Input
2	Ch. 2 - Phase Green Input
3	No Connection
4	Ch. 1 Loop Input
5	Ch. 1 Loop Input
6	No Connection
7	Ch. 1 TS 2 Status Output
8	Ch. 2 Loop Input
9	Ch. 2 Loop Input
10	No Connection
11	No Connection
12	No Connection
13	No Connection
14	No Connection
15	No Connection
16	No Connection
17	No Connection
18	No Connection
19	No Connection
20	Ch. 2 TS 2 Status Output
21	No Connection
22	No Connection

Pin	Function
A	D.C. (-) Common
B	D.C. (+) Power
C	Reset Input
D & 4	Ch. 1 Loop Input
E & 5	Ch. 1 Loop Input
F	Ch. 1 Output, Drain
H	Ch. 1 Output, Source
J & 8	Ch. 2 Loop Input
K & 9	Ch. 2 Loop Input
L	Chassis Ground
M	No Connection
N	No Connection
P & 13	No Connection
R & 14	No Connection
S	No Connection
T	No Connection
U & 17	No Connection
V & 18	No Connection
W	Ch. 2 Output, Drain
X	Ch. 2 Output, Source
Y	No Connection
Z	No Connection

RELAY OUTPUTS

Pin	Function
A	D.C. (-) Common
B	D.C. (+) Power
C	Reset Input
D	Ch. 1 Loop Input
E	Ch. 1 Loop Input
F	Ch. 1 Output, N.O.
H	Ch. 1 Output, Common
J	Ch. 2 Loop Input
K	Ch. 2 Loop Input
L	Chassis Ground
M	No Connection
N	No Connection
P	No Connection
R	No Connection
S	No Connection
T	No Connection
U	No Connection
V	No Connection
W	Ch. 2 Output, N.O.
X	Ch. 2 Output, Common
Y	No Connection
Z	No Connection

Pin	Function
1	Ch. 1 - Phase Green Input
2	Ch. 2 - Phase Green Input
3	No Connection
4	Ch. 1 Loop Input
5	Ch. 1 Loop Input
6	No Connection
7	Ch. 1 TS 2 Status Output
8	Ch. 2 Loop Input
9	Ch. 2 Loop Input
10	No Connection
11	No Connection
12	No Connection
13	No Connection
14	No Connection
15	No Connection
16	No Connection
17	No Connection
18	No Connection
19	No Connection
20	Ch. 2 TS 2 Status Output
21	No Connection
22	No Connection

Pin	Function
A	D.C. (-) Common
B	D.C. (+) Power
C	Reset Input
D & 4	Ch. 1 Loop Input
E & 5	Ch. 1 Loop Input
F	Ch. 1 Output, N.O.
H	Ch. 1 Output, Common
J & 8	Ch. 2 Loop Input
K & 9	Ch. 2 Loop Input
L	Chassis Ground
M	No Connection
N	No Connection
P & 13	No Connection
R & 14	No Connection
S	No Connection
T	No Connection
U & 17	No Connection
V & 18	No Connection
W	Ch. 2 Output, N.O.
X	Ch. 2 Output, Common
Y	No Connection
Z	No Connection

NOTE: All pins not shown have no connection.

Section 4 User Interface

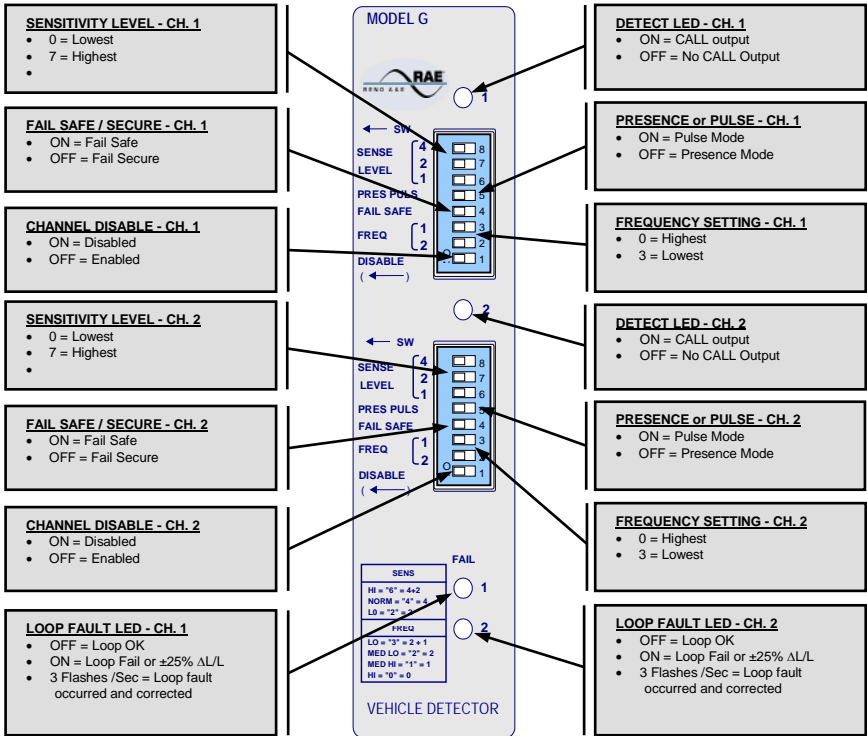

NOTE: There is a two position DIP switch immediately behind the front panel. DIP switch 1 must be in the OFF position for the detector to function properly.

Section 5 Installation and Set-Up

Each channel has a front panel eight (8) position DIP switch to control the operation of the channel. The various switches can be set before or after the detector card is inserted into the card rack wired with appropriate pin assignments. The PRES/PULSE, FAIL-SAFE and DISABLE switches can be pre-selected for the desired operation. The SENSE LEVEL and FREQ switches may require adjustment after the detector card has been inserted. When the detector is inserted, each channel will automatically tune to the loop circuit and begin operation within 2 seconds.

Ensure that DIP switch 1 on the two position DIP switch behind the front panel is set to the OFF position. This switch must be OFF for the detector to operate correctly. Plug the detector into an appropriately wired harness and apply power.

5.1 FRONT PANEL PROGRAMMING DIP SWITCHES

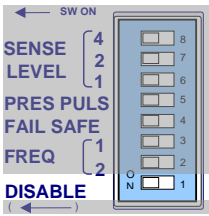

Channel Disable: When DIP switch 1 is in the ON position for a channel, that channel will be disabled. Disabling a channel causes its output to remain in the no call state. This is typically turned ON when a detector channel is not being used or has no loop connected to it. Disabling the channel will keep the FAIL LED from turning ON for channels that do not have loops connected to them. When a channel is disabled, its loop oscillator is disabled as well. Changing this setting will reset the detector.

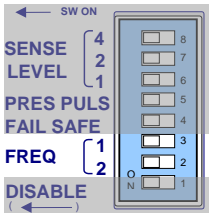

Frequency: Because the detector alternately activates each channel's loop circuit, crosstalk between adjacent loops connected to different channels of the same detector is normally not a concern. However, adjacent loops connected to different detectors may crosstalk and require changing the operating frequency of one of the loop circuits. If crosstalk is a problem, select another loop frequency for stable operation. Each channel of the Model 222 has four frequency selections that allow altering the resonant frequency of the loop circuit. The 4 frequency selections are controlled with 2 switches marked 2 and 3 on the DIP switch. The values (1,2) to the left of the DIP switch are assigned to the switch when the switch is ON. If the switch is OFF, the switch has a value of zero (0). By adding the switch "ON" values, the 2 switches will combine for values from 0 to 3 that indicate the 4 Frequency selections. The following table is a reference for the selections.

Note: It is necessary to reset the detector by momentarily changing one of the other switch positions after changing the frequency switch setting.

Frequency	Switch 2	Switch 3	Switch Value
HI	OFF	OFF	0 + 0 = 0
MED HI	ON	OFF	1 + 0 = 1
MED LO	OFF	ON	0 + 2 = 2
LO	ON	ON	1 + 2 = 3

Fail-Safe / Fail-Secure: This switch selects the Default State of the channel's output when a loop failure condition exists on the loop network to the channel. One of the two output states can be selected during a loop failure condition:

Operation	Fail LED	Call LED	Output State
Fail-Safe	Solid On	Solid On	CALL
Fail-Secure	Solid On	Off	NO CALL

When the switch is in the ON position Fail-Safe operation is selected. Fail-Safe operation during a loop failure is the standard operation for intersection control. When the switch is in the OFF position Fail-Secure operation is selected. Fail-Secure operation during a loop failure is typically used in incident detection systems for freeway management. NOTE: Selecting Fail-Secure also selects fast response (see Response Time).

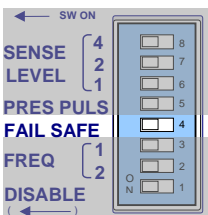

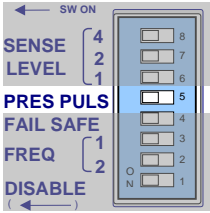

Output Mode: One of the two output modes can be selected for each channel.

PRESENCE (PRES): When the switch is in the ON position the Presence Mode is selected. The Presence Mode will hold the smallest vehicle for 4 minutes minimum and either a small truck or a car typically for one to three hours. This is the factory default setting and the most common setting.

PULSE (PULS): When the switch is in the OFF position the Pulse Mode is selected. The Pulse Mode will generate a single 125 ms pulse output for each vehicle entering the loop detection area. Any vehicle remaining in the loop for over two seconds will be “tuned out” providing full sensitivity for the vacant portion of the loop detection zone. Full sensitivity for the entire loop detection zone is recovered within one second following the departure of any vehicle, which has occupied the loop for longer than two seconds.

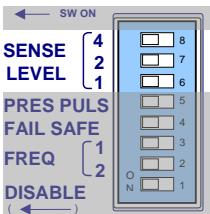

Sensitivity: The detector has eight sensitivity levels that are selected with three switches marked 6, 7, and 8 on the DIP switch for each channel. The values (1, 2, and 4) to the left of the DIP switch are assigned to each switch when the switch is ON. If the switch is OFF, the switch has a value of zero (0). By adding the switch “ON” values, the three switches will combine for values from 0 to 7 indicating which of the eight sensitivity levels has been selected for the channel. Choose the lowest sensitivity level that will consistently detect the smallest vehicle necessary. Do not use any sensitivity level higher than necessary. The factory default position is sensitivity level 4 (-ΔL/L = 0.08%). The following table shows the actual sensitivity for each switch position.

Sensitivity Level	Industry Reference	SW 6	SW 7	SW 8	-ΔL/L Threshold
0		OFF	OFF	OFF	1.28%
1		ON	OFF	OFF	0.64%
2	Low	OFF	ON	OFF	0.32%
3		ON	ON	OFF	0.16%
4	Normal	OFF	OFF	ON	0.08%
5		ON	OFF	ON	0.04%
6	High	OFF	ON	ON	0.02%
7		ON	ON	ON	0.01%

5.2 LOOP FAIL INDICATIONS

The FAIL LED for each channel indicates loop problems according to the following table. The FAIL LED is normally OFF and is not affected by the presence or absence of vehicles in the loop detection area. The FAIL LED provides an indication of either a current or prior out of tolerance condition. A steady “ON” condition indicates a current out of tolerance condition. If the loop “self heals”, the detector will resume operation in a normal manner and the FAIL LED will begin a burst of three flashes once every second, thus providing an alert that the channel has experienced a prior Loop Fail condition.

Fail LED	Meaning
Off	Loop OK
Solid On	Loop Failure or an inductance change of greater than ± 25% condition exists
Burst of 3 flashes every 1 second	Loop Failure condition occurred but no longer exists

5.3 RESETTING THE DETECTOR

Changing any channel switch position (except the Frequency switches) resets the channel. When the detector is installed and operating, the most convenient method for resetting is to momentarily change the DISABLE switch to the “ON” position and then return it to its original position.

Section 6 Block Diagram

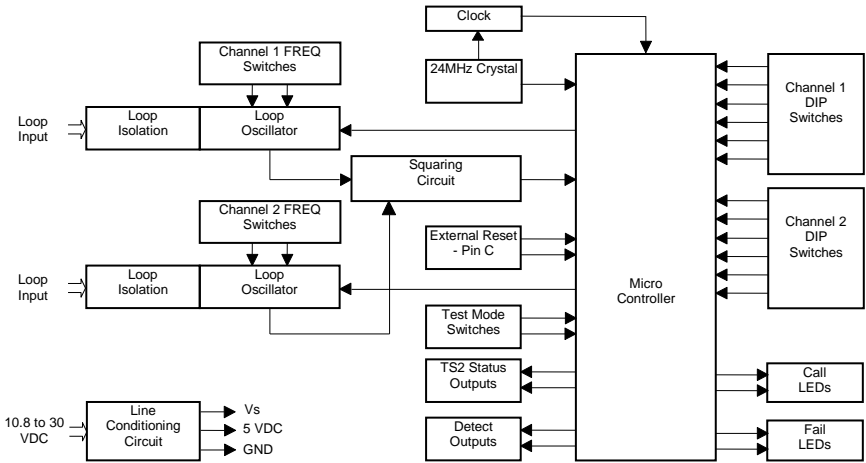

Section 7 Theory of Operation

The Reno A & E Model G and Model 222-1 Detectors digitally measures changes in the resonant frequency of two independent parallel tuned resonant circuits (loop/lead-in) to determine if a vehicle has entered the detection zones. The detector applies an excitation voltage to each loop circuit resulting in the loops oscillating at its resonant frequency. The current flow in the loop wire creates magnetic fields around the loop wire. When a vehicle passes over the loop area, the conductive metal of the vehicle causes a loading of the loop's magnetic fields. The loading decreases the loop inductance, which causes the resonant frequency to increase. By continuously sampling the loop's resonant frequency, the magnitude and rate of change can be determined. If the frequency change exceeds a selectable threshold (set by the sensitivity settings), the detector will activate an output signal. If the rate of change is slow, typical of environmental drift, the detector will continuously track and compensate for the change. The detector also monitors the loop frequency for "out of range conditions" such as an opened or shorted loop circuit.

The detector scans the loop/lead-in circuit connected to each detector channel. The scanning method alternates the on and off cycle of each channel's loop circuit. Each channel's oscillator circuit supplies the excitation voltage that is coupled to the loop circuit by a loop isolation transformer. The transformer provides high common mode isolation between the loop and detector electronics, which allows the detector to operate on poor quality loops including a single short to ground. The transformer also limits the amount of static energy (lightning) that can transfer to the detector electronics. A spark gap transient suppression device is connected across the loop inputs to the isolation transformer. This device will dissipate static charges prior to the transformer. The loop input is also filtered for 60-cycle noise. A network of three capacitors is connected to the detector side of the isolation transformer. The capacitors can be switched in or out of the oscillator circuit to shift the frequency of the loop circuit thus providing frequency separation between adjacent loops.

The sine wave from the loop circuit is squared for the microcontroller to digitally measure the period of several cycles. A high-speed clock sets a reference count for the period in a counter. If the frequency increases, the period is shorter and the period count decreases. By comparing the new count with the reference count, a percentage of change can be calculated that indirectly relates to the inductance change. If the magnitude of the change exceeds a selectable threshold (sensitivity setting), the detector activates the output device.

The rate of change is also monitored. Slow rates of change typical of environmental drift are tracked and automatically compensated. If the total inductance of the loop input network goes out of the range specified for the detector, or rapidly changes by more than $\pm 25\%$, the channel will immediately enter the programmed Fail-Safe or Fail-Secure mode of operation. Fail-Safe operation generates a continuous call output in the Presence Mode and no call in the Pulse Mode. The Fail-Secure operation does not generate a call during the loop failure. In both methods of operation the FAIL LED will turn ON and remain on for as long as the loop fault exists. If the loop "self heals", the channel will resume operation in a normal manner; except the FAIL LED will begin a burst of three flashes every one second, thus providing an alert of a prior Loop Fail condition. The FAIL LED will continue indicating the last loop failure condition until the detector is manually reset or power is removed.

The detector is designed to operate from D.C. power sources providing either 12VDC or 24VDC. On board regulators provide regulated voltages so that either solid state or mechanical relay output versions can safely operate over the full input voltage range of 12VDC to 28VDC. The unit is also provided with an external reset capability. When Pin C receives a logic ground signal for a minimum of 30 microseconds both channels of the detector are immediately reset. Changing any front panel switch (except the frequency switches) resets the associated channel.

The operating parameters of each detector channel are established by DIP switch settings on the front panel. The operating parameters which can be selected on the front panel are: sensitivity, presence/pulse, fail-safe or fail-secure, loop frequency, and channel disable. The loop frequency switches are directly connected to the tuning capacitors in the loop oscillator circuits. The remaining switches settings are strobed into the microprocessor. The microprocessor provides four output signals; a separate output line for each channel and a separate fail status line for each channel. The output lines drive either a "fail-safe" optically isolated transistor or a mechanical relay. Solid state output devices provide faster turn ON and turn OFF times thus giving more accurate information when the detector is used in speed and/or occupancy applications. The fail output signals are connected to two front panel LEDs. The fail LEDs are normally extinguished when the loops are in tolerance and there have been no previous failure conditions. The fail LED will be steady ON when a current out of tolerance/failure condition exists. When the LED flashes with three quick flashes once per second it is an indication that the loop is currently in tolerance; however, the detector has previously experienced an out of tolerance condition. The fail LED flashing condition is reset whenever an external reset occurs on Pin C, the channel is reset, or power is interrupted.

The detector offers a choice of operation either fail-safe or fail-secure. Failsafe operation is the proper choice for intersection control applications where the detector should output a "vehicle detect" condition in the event of either a loop failure or power failure condition. Fail-secure operation is the proper choice for freeway management applications where it is undesirable for the detector to output a "vehicle detect" condition for a loop failure condition. A vehicle detect condition on a freeway would be considered a stalled vehicle. When the detector is operated in the fail-secure mode the detector offers a faster response time than when operated in the failsafe mode.

Slightly slower response times in the failsafe mode allow more filtering; hence providing more noise immunity for intersection control applications.

The Reno A&E Model G and Model 222-1 detectors are designed and manufactured using the latest available technology in electronic design and manufacturing; thus providing the highest possible performance and reliability. Once properly installed a Reno A&E loop detector will provide years of trouble free operation.

Section 8 Maintenance and Troubleshooting

The Reno A & E Model G and Model 222-1 Detectors requires no maintenance. If you are having problems with your Model G or Model 222-1 detector, use the troubleshooting chart below to help determine the cause of the problem.

Symptom	Where To Start
No LEDs lit and detector does not respond to traffic.	See Troubleshooting Power Problems . Check for sensitivity set extremely low (0 to 2).
Both Channel CALL LEDs are ON and cannot be turned OFF, even when the channel is disabled.	Check the RESET line (pin C). The detector is being continually reset.
The LOOP FAIL LED is ON	See Troubleshooting Loop Fail Problems
The LOOP FAIL LED is flashing 3 times per second and detector appears to be working correctly.	See Troubleshooting Intermittent Loop Fail Problems .
Detector intermittently stays in the Call state.	See Troubleshooting Intermittent Detector Lock Ups .

8.1 TROUBLESHOOTING POWER PROBLEMS

Do any of the LEDs blink ON when the detector is powered up?

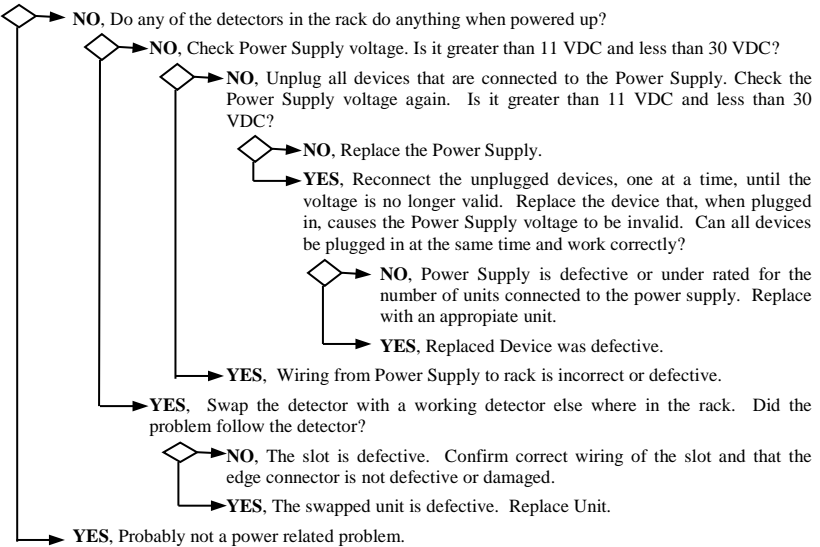

8.2 TROUBLESHOOTING LOOP FAIL PROBLEMS

Is either of the FAIL LEDs lit on the front panel?

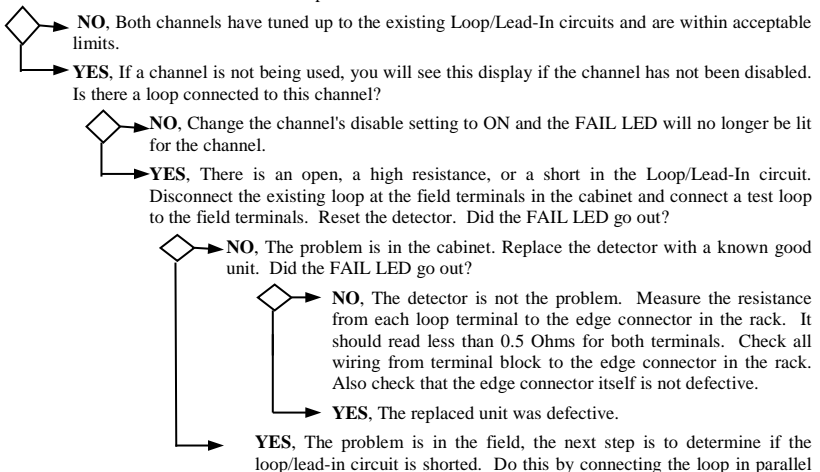

with the test loop that you have installed. Reset the detector. Did the FAIL LED go out?

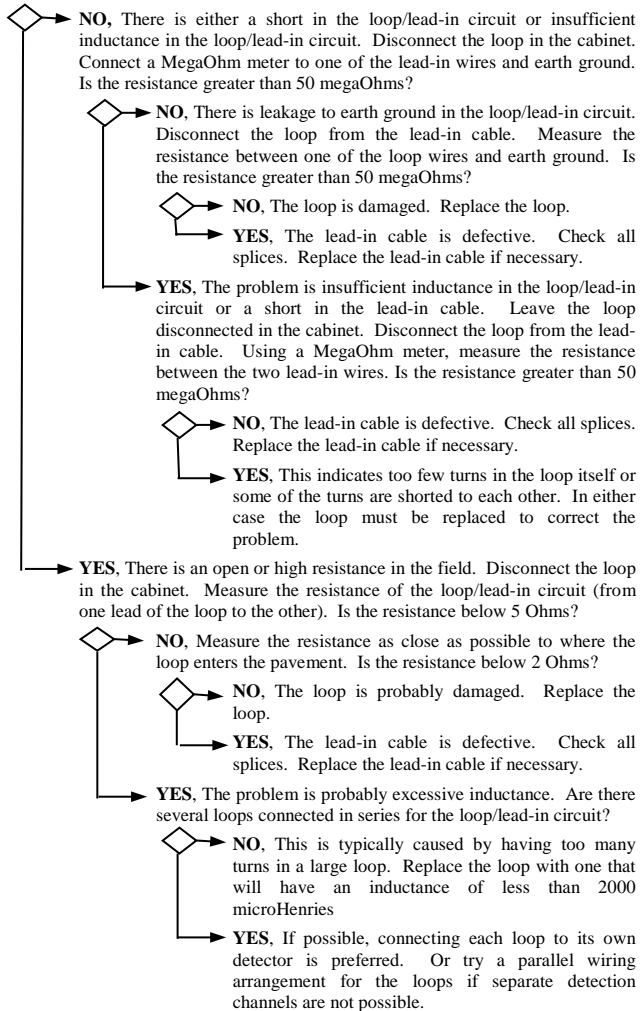

8.3 TROUBLESHOOTING INTERMITTENT LOOP FAIL PROBLEMS

Intermittent Loop Fail problems tend to be bad splices in the Loop/Lead-In circuit, shorts in the Loop/Lead-In circuit, shorts to earth ground in the Loop/Lead-In circuit, or loose connections or bad solder joints in the signal cabinet. If you have any splices that are not soldered and sealed with an adhesive heat shrink or epoxy resin, replace the splice with one that is. Using a MegaOhm meter, measure the resistance from one of the loop wires to earth ground. It should be greater than 50 megaOhms. Inspect the loop. Look for exposed wires or debris pressed into the saw cut. Tighten all screw terminals in the signal cabinet that the loop circuit uses. Check solder joints in the loop circuit, especially on the rack itself. Disconnect and reconnect any connector used in the loop circuit and check for loose pins and sockets in these connectors. If your cabinet has lightning or surge suppression devices on the loop inputs in the cabinet, remove or replace them. Check for places in the field where the loop wire or lead-in cable may be pinched or chaffed. Look for wires pinched under junction box covers and where the wire enters a conduit, especially where the loop wire leaves the saw cut and enters a conduit. If your cabinet has lightning or surge suppression devices on the loop inputs in the cabinet, remove or replace them. After checking all of the above items, you could swap out the detector but this type of failure is rarely ever the detector.

8.4 TROUBLESHOOTING INTERMITTENT DETECTOR LOCK UPS

Problems of this type tend to be difficult to isolate due to the many possible causes and the short duration of the symptom (usually less than 30 minutes). If the problem occurs more frequently in the morning or when raining, suspect a short to earth ground in the loop/lead-in circuit. This can usually be verified by testing with a MegaOhm meter but not always. Vibration can also be a possible cause. Loop wires may be moving slightly in a conduit due to vibrations from truck traffic. Utility lids in the street near the loop may also be a source of problems. Insure that lids near a loop are bolted down so that they cannot move. Check that each set of loop wires is twisted together in any pull boxes and that lengths are not excessive. Inspect the loop. Look for exposed wires or debris pressed into the saw cut. Check for places in the field where the loop wire or lead-in cable may be pinched or chafed. Look for wires pinched under junction box covers and where the wire enters a conduit, especially where the loop wire leaves the saw cut and enters a conduit. **If your cabinet has lightning or surge suppression devices on the loop inputs in the cabinet, remove or replace them.** If you have any splices that are not soldered and sealed with an adhesive heat shrink or epoxy resin, replace the splice with one that is. Solder all crimp connections in the loop circuit. Tighten all screw terminals in the signal cabinet that the loop circuit uses. Check solder joints in the loop circuit, especially on the harness itself. Disconnect and reconnect any connector used in the loop circuit and check for loose pins and sockets in these connectors.

8.5 TEST MODE OPERATION

The Test Mode uses the microcontroller to verify the proper operation of the entire detector's input and output circuitry including switches, LEDs and outputs. Each channel's loop oscillator circuit is also checked to verify the correct frequency in each of the four frequency selections. The frequency portion of the test requires each channel to be connected to a 100 microHenry loop. If an inductance value other than 100 microHenries is used, the frequency test results are invalid.

TEST PROCEDURES:

STEP 1. Set all front panel DIP switches to the "OFF" position.

STEP 2. Set both switches (1 & 2) of the test DIP switch (SW3), located behind the front panel, to the "OFF" position. Set switch 1 of the test DIP switch (SW3) to the "ON" position and apply power. All the LED indicators should be OFF. Note: To test the frequency range the channel must be connected to a 100 microHenry loop!! The other tests may be performed with any loops within the range of 20 to 2000 microHenries.

STEP 3. Individually, turn ON each switch of the Channel 1 DIP switch. Turn OFF each switch after verifying the results indicated in the chart below:

Switch Label	Switch #	LED Indications and Outputs	Channel 1 Test Components Verified
SENS 4	8	CH 1 CALL "ON" CH1 OUTPUT "ON"	SW1-P8, DA1, LED1, R23, U8A, Q15, R21, R33
SENS 2	7	CH 2 CALL "ON" CH2 OUTPUT "ON"	SW1-P7, DA1, LED2, R24, U8B, Q16, R22, R34
SENS 1	6	CH 1 FAIL "ON"	SW1-P6, DA2, LED3, R17
PRES PULS	5	CH 2 FAIL "ON"	SW1-P5, DA2, LED4, R18
FAIL SAFE	4	CH 1 & 2 CALL FLASHING	SW1-P4, DA3
DISABLE	1	CH 1 & 2 FAIL FLASHING	SW1-P1, DA3

Step 4. Individually, turn ON each switch of the Channel 2 DIP switch. Turn OFF each switch after verifying the results indicated in the chart below:

Switch Label	Switch #	LED Indications and Outputs	Channel 2 Test Components Verified
SENS 4	8	CH 1 CALL "ON" CH1 OUTPUT "ON"	SW2-P8, DA4, LED1, R23, U8A, Q15, R21, R33
SENS 2	7	CH 2 CALL "ON" CH2 OUTPUT "ON"	SW2-P7, DA4, LED2, R24, U8B, Q16, R22, R34
SENS 1	6	CH 1 FAIL "ON"	SW2-P6, DA5, LED3, R17
PRES PULS	5	CH 2 FAIL "ON"	SW2-P5, DA5, LED4, R18
FAIL SAFE	4	CH 1 & 2 CALL FLASHING	SW2-P4, DA6
DISABLE	1	CH 1 & 2 FAIL FLASHING	SW2-P1, DA6

Step 5. To test the frequency range each channel must have a 100 microHenry loop connected. Start with all the front panel switches turned "OFF". Then one by one set the switches and verify the results as indicated in the chart below:

	FREQ 1	FREQ 2	LED Indications	Components Verified
CH 1	OFF	OFF	CH 1 & 2 CALL "OFF"	T1, Q1-4, U3A-B, U4A, C3, C16, R3-7, R13-16, R31
	ON	OFF	CH 1 CALL "ON"	SW1-P3, C4 (also above)
	OFF	ON	CH 2 CALL "ON"	SW1-P2, C5 (also above)
	ON	ON	CH 1 & 2 CALL "ON"	C4 & C5 combined

CH 2	OFF	OFF	CH 1 & 2 FAIL "OFF"	T2, Q5-8, U3A-B, U4A, C6, C17, R8-12, R13-16, R31
	ON	OFF	CH 1 FAIL "ON"	SW2-P3, C7 (also above)
	OFF	ON	CH 2 FAIL "ON"	SW2-P2, C8 (also above)
	ON	ON	CH 1 & 2 FAIL "ON"	C7 & C8 combined

An LED indication different than the ones described for each switch setting indicates the loop frequency is out of tolerance. Verify that the loop test coil is 100 microHenries. If the test loop measures 100 microHenries the detector module should be serviced. For reference, the circuit components verified are listed in the Test Charts.

8.6 VOLTAGE & WAVEFORM MEASUREMENTS

The following voltage and waveform measurements are referenced to logic ground on Pin A of the card edge connector.

- Verify 10.8 to 27 VDC on Pin B of the card edge connector.
- Verify 5 VDC on the following:
 - Pin 3 of U6 (regulator)
 - Pin 20 (VCC) and Pin 1 (Reset) of U1 (microcontroller)
- Verify channel 1 & 2 oscillator sine wave (shown in Figure 1) forms across LA1 and LA2 (surge protectors). The sine wave should be 8 to 10 Vp-p and between 20 and 100 kHz.
- Verify channel 1 & 2 oscillator scan signals (shown in Figure 2) on Pin 2 & 3 of U1 respectively.
- Verify the comparator square wave on Pin 1 of U4A (Figure 3). Turn OFF one of the channels with the front panel DISABLE switch to verify the operation of the other channel.
- Verify the operation of the crystal on Pin 10 of U1 (Figure 4).

WAVE FORMS

Figure 1.

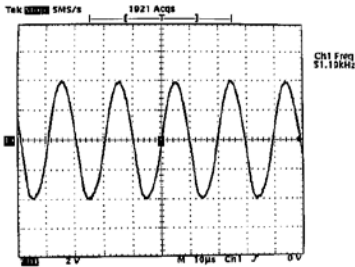

Figure 3.

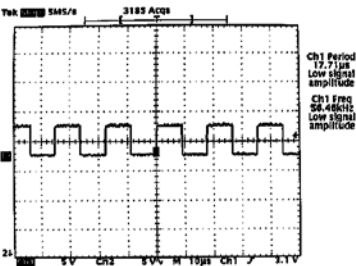

Figure 2.

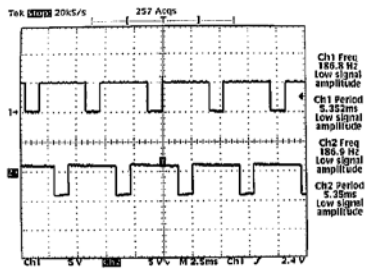
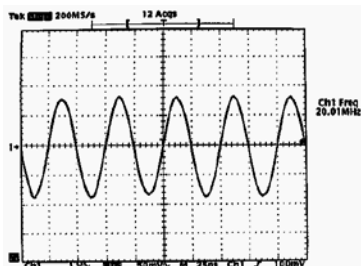

Figure 4.



8.7 THINGS TO KNOW ABOUT LOOPS

Always use a wire with cross-linked Polyethylene insulation (insulation type XLPE) for loop wire.

Typical sensing height is 2/3 of the shortest leg of a loop. Therefore, a 6' x 6' loop will have a detection height of 4'.

The inductance of a conventional four-sided loop can be estimated using the formula:

$$L = P \times (T^2 + T) / 4$$

Where: L = Loop Inductance in microhenries
P = Loop Perimeter in feet
T = Number of Turns of Wire.

Therefore, a 6' by 6' loop with 3 turns would have an inductance of:

$$\begin{aligned} L &= (6 + 6 + 6 + 6) \times (3^2 + 3) / 4 \\ L &= 24 \times (9 + 3) / 4 \\ L &= 24 \times 12 / 4 \\ L &= 24 \times 3 \\ L &= 72 \text{ microhenries.} \end{aligned}$$

The inductance of a QuadropoleTM loop can be estimated using the formula:

$$L = [P \times (T^2 + T) / 4] + [CL \times (T^2 + T) / 4]$$

Where: L = Loop Inductance in microhenries
P = Loop Perimeter in feet
T = Number of Turns of Wire
CL = Length of Center Leg in feet.

Therefore, a 6' by 50' loop with a 2-4-2 configuration would have an inductance of:

$$\begin{aligned} L &= [(6 + 50 + 6 + 50) \times (2^2 + 2) / 4] + [50 \times (4^2 + 4) / 4] \\ L &= [112 \times (4 + 2) / 4] + [50 \times (16 + 4) / 4] \\ L &= (112 \times 6 / 4) + (50 \times 20 / 4) \\ L &= (112 \times 1.5) + (50 \times 5) \\ L &= 168 + 250 \\ L &= 418 \text{ microhenries.} \end{aligned}$$

Loop Feeder cable typically adds 0.22 microhenries of inductance per foot of cable.

Total inductance of loops connected in series:

$$L_{TOTAL} = L_1 + L_2 + L_3 + \dots + L_N.$$

Total inductance of loops connected in parallel:

$$L_{TOTAL} = 1 / [(1 / L_1) + (1 / L_2) + (1 / L_3) + \dots + (1 / L_N)].$$

Section 10 PCB Layout

Top View

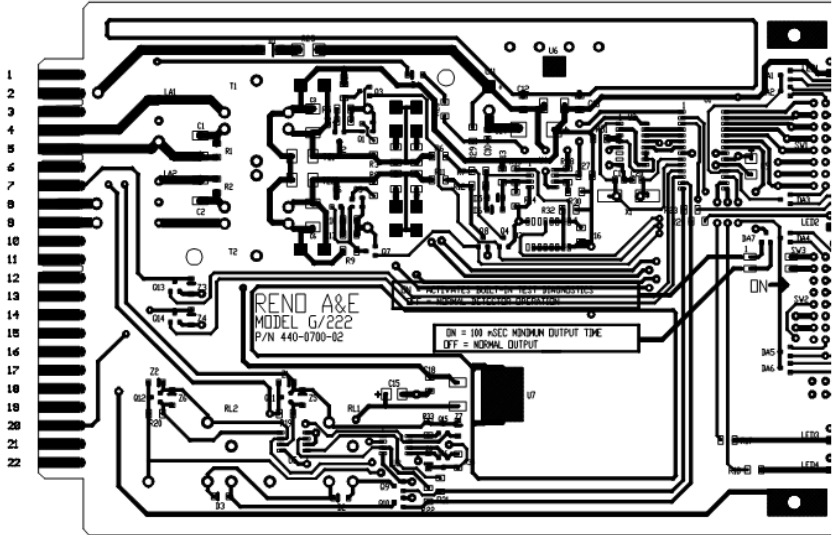

Parts Locator

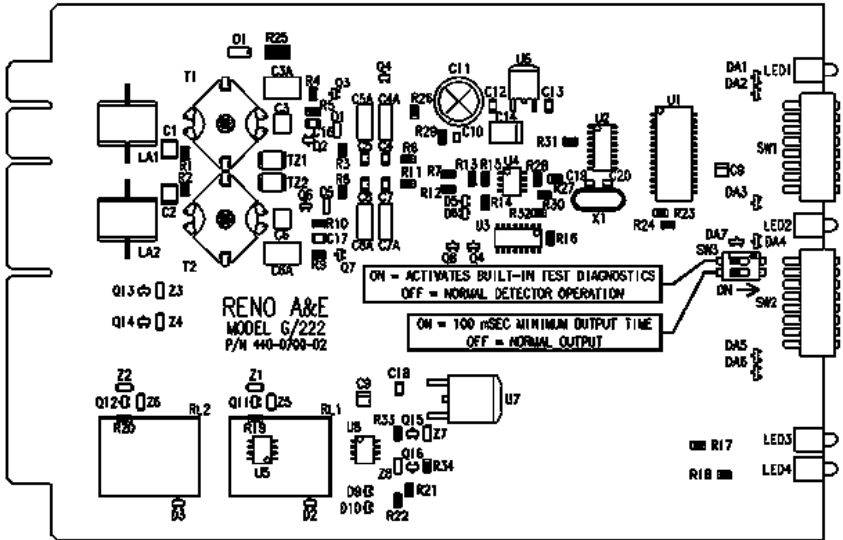

Bottom View

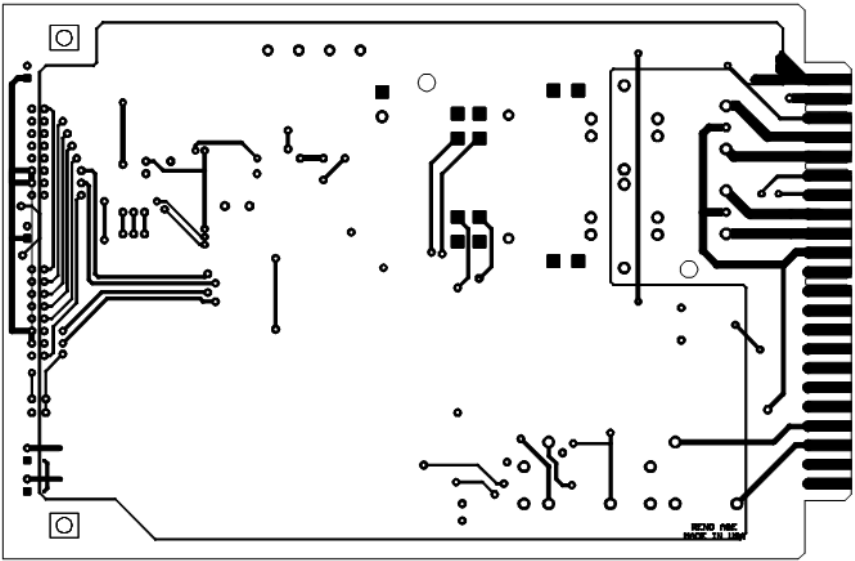

Section 11 Parts List

SMT denotes a Surface Mount device; TH denotes a Through Hole device

			MODEL	222 SS	222-1 SS	222 Relay	G SS	G Relay
PART	PART NUMBER	DESCRIPTION	0750	0752	0751	0700	0701	
PCB	440-0700-02	PRINTED CIRCUIT BOARD	X	X	X	X	X	X
C1	020-0684-00	SMT CAPACITOR, X7R, 0.68uF, 50V	X	X	X	X	X	X
C2	020-0684-00	SMT CAPACITOR, X7R, 0.68uF, 50V	X	X	X	X	X	X
C3	021-0683-00 220-0683-00	SMT CAPACITOR, PPS, .068uF, 50V -OR- TH CAPACITOR, METALIZED POLYPROPYLENE, 0.068uF, 100V	X	X	X	X	X	X
C4	021-0103-00 220-0103-00	SMT CAPACITOR, PPS, .01uF, 50V -OR- TH CAPACITOR, METALIZED POLYPROPYLENE, 0.01uF, 100V	X	X	X	X	X	X
C5	021-0223-00 220-0223-00	SMT CAPACITOR, PPS, .022uF, 50V -OR- TH CAPACITOR, METALIZED POLYPROPYLENE, 0.022uF, 100V	X	X	X	X	X	X
C6	021-0683-00 220-0683-00	SMT CAPACITOR, PPS, .068uF, 50V -OR- TH CAPACITOR, METALIZED POLYPROPYLENE, 0.068uF, 100V	X	X	X	X	X	X
C7	021-0103-00 220-0103-00	SMT CAPACITOR, PPS, .01uF, 50V -OR- TH CAPACITOR, METALIZED POLYPROPYLENE, 0.01uF, 100V	X	X	X	X	X	X
C8	021-0223-00 220-0223-00	SMT CAPACITOR, PPS, .022uF, 50V -OR- TH CAPACITOR, METALIZED POLYPROPYLENE, 0.022uF, 100V	X	X	X	X	X	X
C9	025-0106-00	SMT CAPACITOR, TANTALUM, 10uF, 16V, B PACKAGE	X	X	X	X	X	X
C10	022-0271-00	SMT CAPACITOR, NPO, 270pF, 0805	X	X	X	X	X	X
C12	020-0104-00	SMT CAPACITOR, X7R, 0.1uF, 50V	X	X	X	X	X	X
C13	020-0104-00	SMT CAPACITOR, X7R, 0.1uF, 50V	X	X	X	X	X	X
C14	025-0107-00	SMT CAPACITOR, TANTALUM, 100uF, 6.3V, D PACKAGE	X	X	X	X	X	X
C15	025-0106-00	SMT CAPACITOR, TANTALUM, 10uF, 16V, B PACKAGE			X			X
C16	020-0683-00	SMT CAPACITOR, X7R, 0.068uF, 50V	X	X	X	X	X	X
C17	020-0683-00	SMT CAPACITOR, X7R, 0.068uF, 50V	X	X	X	X	X	X
C18	020-0104-00	SMT CAPACITOR, X7R, 0.1uF, 50V			X			X
C19	022-0220-00	SMT CAPACITOR, NPO, 22pF, 0805	X	X	X	X	X	X
C20	022-0220-00	SMT CAPACITOR, NPO, 22pF, 0805	X	X	X	X	X	X

X USE
OMIT

D1	064-4004-00	SMT DIODE, POWER, RECTIFIER, SMA						
D2	060-1914-00	SMT DIODE, SMALL SIGNAL, SOD123			X		X	X
D3	060-1914-00	SMT DIODE, SMALL SIGNAL, SOD123			X			X
D4	060-1914-00	SMT DIODE, SMALL SIGNAL, SOD123	X	X	X	X	X	X
D5	060-1914-00	SMT DIODE, SMALL SIGNAL, SOD123	X	X	X	X	X	X
D6	060-1914-00	SMT DIODE, SMALL SIGNAL, SOD123	X	X	X	X	X	X
DA1	069-0000-00	SMT DIODE, ARRAY, DUAL	X	X	X	X	X	X
DA2	069-0000-00	SMT DIODE, ARRAY, DUAL	X	X	X	X	X	X
DA3	069-0000-00	SMT DIODE, ARRAY, DUAL	X	X	X	X	X	X
DA4	069-0000-00	SMT DIODE, ARRAY, DUAL	X	X	X	X	X	X
DA5	069-0000-00	SMT DIODE, ARRAY, DUAL	X	X	X	X	X	X
DA6	069-0000-00	SMT DIODE, ARRAY, DUAL	X	X	X	X	X	X
DA7	069-0000-00	SMT DIODE, ARRAY, DUAL	X		X	X	X	X
Q1	044-0005-00	SMT TRANSISTOR, COMMON BASE, ARRAY, NPN, PAIR	X	X	X	X	X	X
Q2	040-3904-00	SMT TRANSISTOR, SMALL SIGNAL, NPN, SOT23	X	X	X	X	X	X
Q3	041-0002-00	SMT TRANSISTOR, DRIVER, NPN, SOT23, DTC	X	X	X	X	X	X
Q4	041-0002-00	SMT TRANSISTOR, DRIVER, NPN, SOT23, DTC	X	X	X	X	X	X
Q5	044-0005-00	SMT TRANSISTOR, COMMON BASE, ARRAY, NPN, PAIR	X	X	X	X	X	X
Q6	040-3904-00	SMT TRANSISTOR, SMALL SIGNAL, NPN, SOT23	X	X	X	X	X	X
Q7	041-0002-00	SMT TRANSISTOR, DRIVER, NPN, SOT23, DTC	X	X	X	X	X	X
Q8	041-0002-00	SMT TRANSISTOR, DRIVER, NPN, SOT23, DTC	X	X	X	X	X	X
Q9	041-0002-00	SMT TRANSISTOR, DRIVER, NPN, SOT23, DTC			X			X
Q10	041-0002-00	SMT TRANSISTOR, DRIVER, NPN, SOT23, DTC			X			X
Q11	043-0000-00	SMT TRANSISTOR, FET, P-CHANNEL, SOT23, FDN340P						
Q12	043-0000-00	SMT TRANSISTOR, FET, P-CHANNEL, SOT23, FDN340P						
Q13	041-0002-00	SMT TRANSISTOR, DRIVER, NPN, SOT23, DTC					X	X
Q14	041-0002-00	SMT TRANSISTOR, DRIVER, NPN, SOT23, DTC					X	X
Q15	042-0001-00	SMT TRANSISTOR, DARLINGTON, NPN, SOT23, 2SD1383	X	X			X	
Q16	042-0001-00	SMT TRANSISTOR, DARLINGTON, NPN, SOT23, 2SD1383	X	X			X	
R1	001-0390-00	SMT RESISTOR, 1206, 39 OHM	X	X	X	X	X	X
R2	001-0390-00	SMT RESISTOR, 1206, 39 OHM	X	X	X	X	X	X
R3	001-0432-00	SMT RESISTOR, 1206, 4.3K OHM	X	X	X	X	X	X
R4	001-0362-00	SMT RESISTOR, 1206, 3.6K OHM	X	X	X	X	X	X
R5	001-0680-00	SMT RESISTOR, 1206, 68 OHM	X	X	X	X	X	X
R6	001-0242-00	SMT RESISTOR, 1206, 2.4K OHM	X	X	X	X	X	X
R7	001-0243-00	SMT RESISTOR, 1206, 24K OHM	X	X	X	X	X	X
R8	001-0432-00	SMT RESISTOR, 1206, 4.3K OHM	X	X	X	X	X	X

			MODEL	222 SS	222-1 SS	222 Relay	G SS	G Relay
PART	PART NUMBER	DESCRIPTION	0750	0752	0751	0700	0701	
R9	001-0362-00	SMT RESISTOR, 1206, 3.6K OHM	X	X	X	X	X	X
R10	001-0680-00	SMT RESISTOR, 1206, 68 OHM	X	X	X	X	X	X
R11	001-0242-00	SMT RESISTOR, 1206, 2.4K OHM	X	X	X	X	X	X
R12	001-0243-00	SMT RESISTOR, 1206, 24K OHM	X	X	X	X	X	X
R13	001-0273-00	SMT RESISTOR, 1206, 27K OHM	X	X	X	X	X	X
R14	001-0243-00	SMT RESISTOR, 1206, 24K OHM	X	X	X	X	X	X
R15	001-0394-00	SMT RESISTOR, 1206, 390K OHM	X	X	X	X	X	X
R16	001-0162-00	SMT RESISTOR, 1206, 1.6K OHM	X	X	X	X	X	X
R17	001-0511-00	SMT RESISTOR, 1206, 510 OHM	X	X	X	X	X	X
R18	001-0511-00	SMT RESISTOR, 1206, 510 OHM	X	X	X	X	X	X
R19	001-0105-00	SMT RESISTOR, 1206, 1M OHM						
R20	001-0105-00	SMT RESISTOR, 1206, 1M OHM						
R21	001-0162-00	SMT RESISTOR, 1206, 1.6K OHM	X	X			X	
R22	001-0162-00	SMT RESISTOR, 1206, 1.6K OHM	X	X			X	
R23	001-0511-00	SMT RESISTOR, 1206, 510 OHM	X	X	X	X	X	X
R24	001-0511-00	SMT RESISTOR, 1206, 510 OHM	X	X	X	X	X	X
R25	002-0100-00	SMT RESISTOR, 2010, 10 OHM	X	X	X	X	X	X
R26	001-0123-00	SMT RESISTOR, 1206, 12K OHM	X	X	X	X	X	X
R27	001-0472-00	SMT RESISTOR, 1206, 4.7K OHM	X	X	X	X	X	X
R28	001-0243-00	SMT RESISTOR, 1206, 24K OHM	X	X	X	X	X	X
R29	001-0123-00	SMT RESISTOR, 1206, 12K OHM	X	X	X	X	X	X
R30	001-0243-00	SMT RESISTOR, 1206, 24K OHM	X	X	X	X	X	X
R31	001-0472-00	SMT RESISTOR, 1206, 4.7K OHM	X	X	X	X	X	X
R32	001-0472-00	SMT RESISTOR, 1206, 4.7K OHM	X	X	X	X	X	X
R33	001-0563-00	SMT RESISTOR, 1206, 56K OHM	X	X			X	
R34	001-0563-00	SMT RESISTOR, 1206, 56K OHM	X	X			X	
SW3	121-0002-00	SMT SWITCH, DIP, 2 POSITION, FACE UP	X			X	X	X
TZ1	068-0075-00	SMT DIODE, TRANZORB, 7.5V, SMB	X	X	X	X	X	X
TZ2	068-0075-00	SMT DIODE, TRANZORB, 7.5V, SMB	X	X	X	X	X	X
U1	097-0705-00	SMT OTP PROCESSOR, G, CODED, G05	X	X	X	X	X	X
U1	098-0705-00	SMT MASK ROM PROCESSOR, G, CODED, G05	X	X	X	X	X	X
U2	095-0700-00	SMT DIGITAL IC, LOGIC, 74HC112	X	X	X	X	X	X
U3	095-0700-00	SMT DIGITAL IC, LOGIC, 74HC112	X	X	X	X	X	X
U4	094-0201-00	SMT LINEAR IC, COMPARATOR, LM393	X	X	X	X	X	X
U5	094-0700-00	SMT LINEAR IC, OPTO COUPLER, MOCD208, BJT OUTPUT						
U6	094-0402-00	SMT LINEAR IC, REGULATOR, 78M05	X	X	X	X	X	X
U7	094-0401-00	SMT LINEAR IC, REGULATOR, 7805				X		X

X	USE
	OMIT

U8	094-0700-00	SMT LINEAR IC, OPTO COUPLER, MOCD208, BJT OUTPUT	X	X			X	
Z1	067-0330-00	SMT DIODE, ZENER, 33V, SOD123						
Z2	067-0330-00	SMT DIODE, ZENER, 33V, SOD123						
Z3	067-0330-00	SMT DIODE, ZENER, 33V, SOD123					X	X
Z4	067-0330-00	SMT DIODE, ZENER, 33V, SOD123					X	X
Z5	067-0180-00	SMT DIODE, ZENER, 18V, SOD123						
Z6	067-0180-00	SMT DIODE, ZENER, 18V, SOD123						
Z7	067-0330-00	SMT DIODE, ZENER, 33V, SOD123	X	X			X	
Z8	067-0330-00	SMT DIODE, ZENER, 33V, SOD123	X	X	X		X	
C11	226-0477-00	TH CAPACITOR, ELECTROLYTIC, 470uF, 35V	X	X	X	X	X	X
J1	385-0022-00	WIRE & CABLE, BUS WIRE, 22AWG		X				
J2	385-0022-00	WIRE & CABLE, BUS WIRE, 22AWG		X				
LA1	349-0004-00	TH TRANSIENT PROTECTION, SPARK GAP, 3 PRONG	X	X	X	X	X	X
LA2	349-0004-00	TH TRANSIENT PROTECTION, SPARK GAP, 3 PRONG	X	X	X	X	X	X
LED1	341-0002-00	TH LED, RIGHT ANGLE, RED	X	X	X	X	X	X
LED2	341-0002-00	TH LED, RIGHT ANGLE, RED	X	X	X	X	X	X
LED3	341-0002-00	TH LED, RIGHT ANGLE, RED	X	X	X	X	X	X
LED4	341-0002-00	TH LED, RIGHT ANGLE, RED	X	X	X	X	X	X
RL1	350-0012-00	TH RELAY, 12VDC, SENSITIVE				X	X	X
RL2	350-0012-00	TH RELAY, 12VDC, SENSITIVE				X	X	X
SW1	321-0008-00	TH SWITCH, DIP, 8 POSITION, RIGHT ANGLE	X	X	X	X	X	X
SW2	321-0008-00	TH SWITCH, DIP, 8 POSITION, RIGHT ANGLE	X	X	X	X	X	X
T1	348-1002-00	TH TRANSFORMER, ISOLATION, POTCORE, AL800	X	X	X	X	X	X
T2	348-1002-00	TH TRANSFORMER, ISOLATION, POTCORE, AL800	X	X	X	X	X	X
X1	355-0206-00	TH CRYSTAL, 20 MHz	X	X	X	X	X	X
X1	155-0206-00	SMT CRYSTAL, 20 MHz						

X	USE
	OMIT